

پودمان ۵

کسب اطلاعات فنی صنایع نساجی

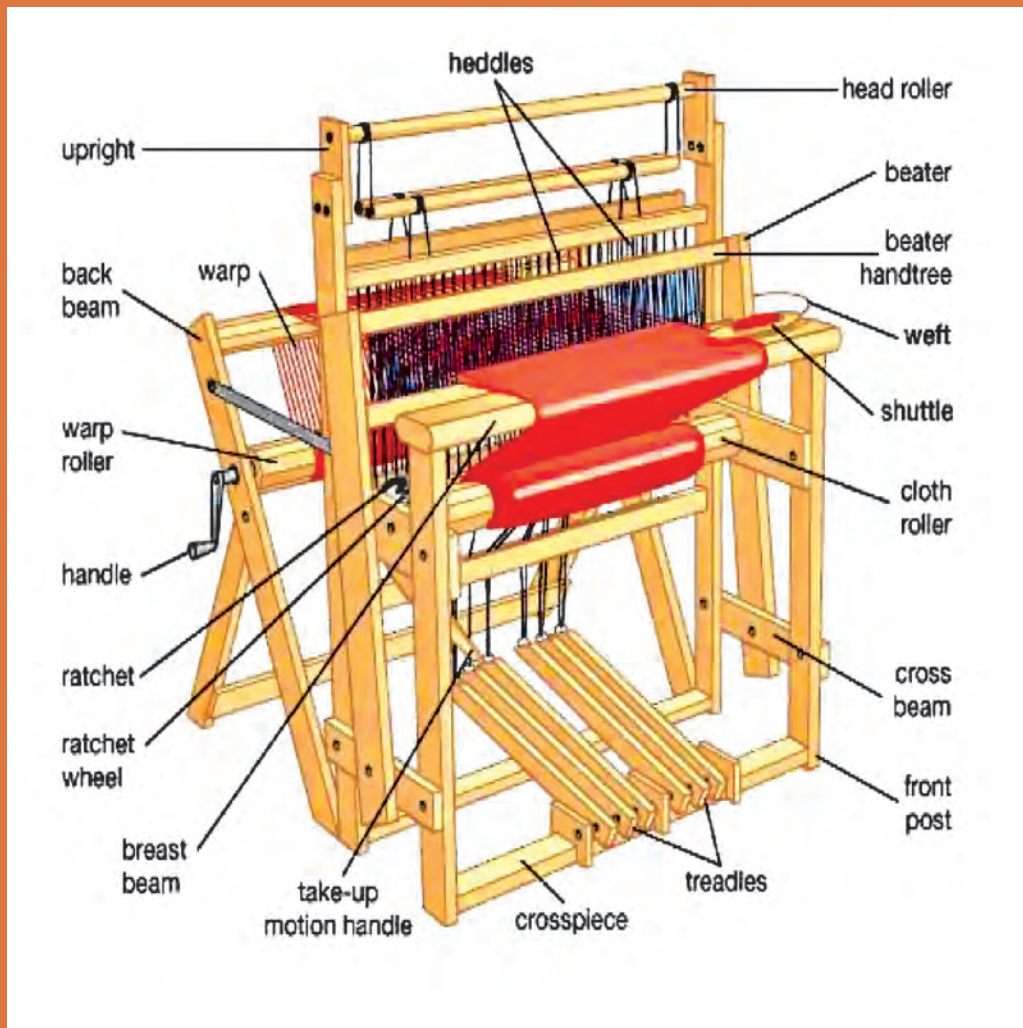

آیا می‌دانید که:

- الیاف نساجی چیست و چگونه طبقه‌بندی می‌شوند؟
- ویژگی‌های الیاف پنبه، ابریشم و پلی‌استر چیست؟
- روش کار ماشین‌های ریسندگی چگونه است؟
- محصول دستگاه نیم‌تاب و تمام‌تاب چه نام دارد؟
- بافندگی تار-پودی با بافندگی حلقوی چه تفاوتی دارد؟
- چگونه از کاتالوگ رنگ استفاده می‌شود؟
- رمزگذاری‌های استفاده‌شده در نام ماشین‌های بافندگی و رنگ‌های نساجی چیست؟

استاندارد عملکرد

انتظار می‌رود پس از آموزش این پودمان، هنرجو نام الیاف و خصوصیات آنها را بداند. اهمیت خصوصیات الیاف و کاربرد آنها را بداند و روش‌های ریسندگی الیاف پنبه‌ای و نحوه محاسبات و ماشین‌آلات به کار رفته را فراگیرد. بافندگی و عملیات چاپ و تکمیل نساجی و نحوه کاربرد کاتالوگ‌ها را یاد بگیرد.

مقدمه کسب اطلاعات فنی

با پیشرفت و گسترش و تنوع منابع ضرورت است که برای تحقق اهداف و توسعه شایستگی‌های خود به منابع و مراجع غیر فارسی نیز مراجعه کنیم. در این راستا پودمان حاضر به همین منظور در کتاب دانش فنی تخصصی طراحی و تألیف شده است. پودمان «کسب اطلاعات فنی» با هدف یادگیری مادام‌العمر و توسعه شایستگی‌های هنرجویان بعد از دنیای آموزش و ورود به بازار کار، سازماندهی محتوایی شده است. این امر با آموزش چگونگی استخراج اطلاعات فنی موردنیاز از متون فنی غیرفارسی و جداول، راهنمای ماشین آلات و تجهیزات صنعتی، دستگاه‌های اداری، خانگی و تجاری و درک مطلب آنها در راستای توسعه شایستگی‌های حرفه‌ای محقق خواهد شد.

در این پودمان اطلاعات فنی راجع به مواد اولیه در صنعت نساجی و عملیاتی که بر روی مواد اولیه انجام می‌شود و دستگاه‌هایی که در این مسیر کاربرد دارد و موادی که در نهایت تولید می‌شود را به زبان می‌آموزیم و شیوه کاربردی دستگاه‌ها، ماشین‌ها و تجهیزات مرتبط با صنایع نساجی را از طریق بروشورها، کاتالوگ‌ها و کتاب‌های راهنمایی کار با دستگاه‌ها را کسب می‌کنیم.

بدیهی است هدف از ارائه این پودمان، تدریس زبان انگلیسی نمی‌باشد بلکه کسب اطلاعات فنی و تخصصی، حرفه خود می‌باشد. از طریق خواندن منابع ذکر شده می‌توان به این هدف دست یافت. البته برای پشتیبانی این امر در کتاب همراه هنرجو، که خود نیز عملاً یک دانشنامه ویژه بیشتر به خواندن درست لغات، جملات و درک مطالب ارائه شده در کاتالوگ‌ها، بروشور و کتاب‌های راهنمای کاربری تأکید دارد. پودمان ذکر شده حاوی یک لوح فشرده (CD) آموزشی نیز می‌باشد. در این لوح مطالب ارائه شده در درس به زبان اصلی بیان می‌شود تا راهنمایی در خواندن و گفتار باشد. برای کامل شدن روش درست کسب اطلاعات فنی به نکات زیر توجه کنید.

۱ فرهنگ‌های ترجمه لغات که به صورت کتاب چاپ شده است بسیار مفید است ولی خوشبختانه دیکشنری‌های سیار که بر روی گوشی‌ها تلفن همراه قابل نصب است بسیار کارگشا می‌باشد. حتماً یکی از دیکشنری انگلیسی به فارسی و فارسی به انگلیسی روی گوشی خود نصب کنید. دیکشنری‌های ویژه نساجی نیز بسیار ارزشمند است زیرا معنی کلمات تخصصی در دیکشنری عمومی وجود ندارد.

۲ از ابزار ترجمه موجود روی گوگل استفاده کنید.

۳ ابزار ترجمه مستقیم فایل‌های ورد docx. و پی‌دی اف pdf را به کار بگیرید.

۴ از ابزارهای ترجمه متون روی عکس استفاده کنید. با قرار دادن تصویر که به زبان غیر از فارسی، مقابل گوشی و عکس گرفتن، ترجمه لغات روی نوشته بر روی تصویر نمایان می‌شود.

به کمک روش‌های فوق، درک مطالب غیر فارسی نیز برای شما آسان می‌شود. با توجه به کاربرد وسیع زبان انگلیسی در کاتالوگ‌های نساجی، کاتالوگ‌های مرتبط با نساجی را ترجمه کنید و آن را به کار ببرید.

گروه صنایع نساجی

What Is Textile?

The word "textile" originally applied only to woven fabrics, now generally applied to fibers, yarns, or fabrics or products made offers, yarns or fabrics. The term textile originates from the latin verb texere to weave but, as the Textile Institute's Terms and Definitions Glossary explains, it is now "a general term applied to any manufacture from fibers, filaments or yarns characterized by flexibility, fineness and high ratio of Length to thickness"

Textiles, especially fabrics the fundamental component of a ready made garment, because it is the basic raw material of a garment. So it is important to know the manufacturing sequence of fabric from fiber. The quality product is the main goal at present time, Without knowledge of Textile manufacturing i.e. fiber, yarn and fabrics it is impossible to maintain the quality of a garment. Before elaborating on whole process of grey fabric manufacturing Let us look on what is textile fiber, yarn and fabric and what are the process flow chart of Textile manufacturing can be described.

Normally, textile is a woven fabric; now applied generally to any one of the following:

- 1 Staple fibers and filaments suitable for conversion to or use as yarns, or for the preparation of woven, knit, or nonwoven fabrics. Fig -1



Filament Fiber



Staple Fiber

Fig 1- Fibers

- 2 Yarns made from natural or manufactured fibers.
- 3 Fabrics and other manufactured products made from fibers as defined above and from yarns.
- 4 Garments and other articles fabricated from fibers, yarns, or fabrics when the products retain the characteristic flexibility and drape of the original fabrics.

Textile is a very widely used term which includes

- 1 All kinds of fibers (e.g: Cotton, Jute, Wool, Polyester, Viscose & etc.)
- 2 All kinds of Process (e.g: Spinning, Weaving, Knitting, Dyeing, Printing, Finishing & etc.)
- 3 All kinds of machineries (e.g: Spinning machineries, Weaving machineries, Knitting machineries, Dyeing machineries, Testing machineries & etc.)
- 4 To convert textile fiber into finished or end use products (e.g: Garments, Technical textiles, Geo textiles, Medical textiles, E-textiles (Electronic textikle) & etc.)

زیر هر شکل با توجه به موارد چهارگانه که در متن اشاره شده است کلمه مناسبی را بنویسید.



Fig 2

Classification of Textile Fiber (Fibre)

Textile fibers are divided into two categories these two groups are:

- 1 Natural fiber.
- 2 Manmade fiber.

Natural fiber

Natural fibers include those produced by plants, animals, and geological processes. They are biodegradable over time. They can be classified according to their origin.

Man made fiber

Synthetic or man-made fibers generally come from synthetic materials such as petrochemicals. But some types of synthetic fibers are manufactured from natural cellulose; including rayon, modal, and the more recently developed Lyocell. Cellulose-based fibers are of two types, regenerated or pure cellulose such as from the cupro-ammonium process and modified or derivitized cellulose such as the cellulose acetates. Fig 1, Shows the Group

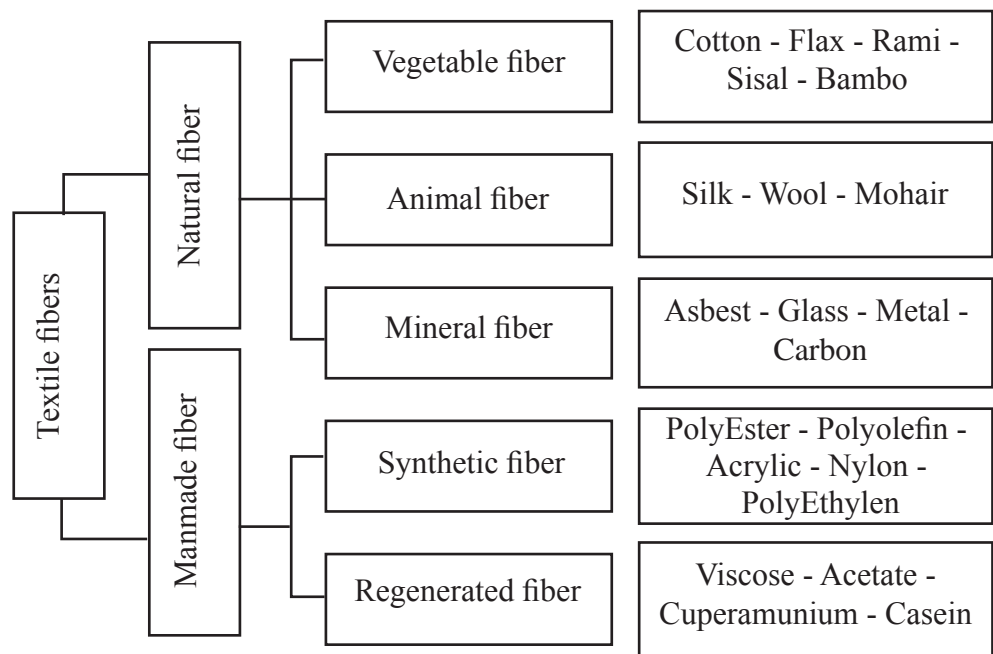

table 1- Classification of Textile Fiber Table

در رایانه، نرم افزار Word را باز کنید و با رسم جدول در سطر بالای جدول نام الیاف و در سطر پایین یک یا چند کاربرد از الیاف و در سطر سوم تصاویری از الیاف و یا کاربرد آن را به انگلیسی بنویسید. مورد استفاده هر کدام از الیاف را بنویسید.

فعالیت
کلاسی ۱

A Sample For NATURAL VEGETABLE FIBER

COTTON FIBER

Cotton is a natural vegetable fibre produced in the cotton plant in many countries of the world even in Bangladesh also. Some important properties of cotton fibres are discussed very briefly below: fig 3: show cotton used



Cotton fiber



Cotton dress



Cotton towel

Fig 3- Cotton Used

Properties of cotton fibres

Length of cotton fiber:

Physically the individual cotton fibres consist of a single long tubular cell. Its length is about 1200 -1500 times than its breadth. Length of cotton fibre varies from 16 mm to 52 mm depending upon the type of cotton.

Fineness of cotton fiber:

Longer the fibre, finer the fibre in case of cotton fibre. It is expressed in term of decitex and it varies from 1.1 to 2.3 decitex.

Fineness may be more in case of immature fibre. So it is necessary to express maturity with fineness.

Strength and extension of cotton fiber:

Cotton fibre is fairly among natural fibres in relation to tenacity which is 3-3.5 g/dtex. Its tensile strength is between wool and silk fibre but disadvantage is low extension at break which is 5-7%.

Cotton Appearance

Cotton fibre is fairly short, fine and creamy white color. Color of the fibre depends on soil of growth. By adding chemicals in the soil, color of the cotton fibre may be varied.

Crimp

Cotton fibre is more or less twisted on its longitudinal axis which can not be seen from outside is called convolution. The twist in the fibre does not to be continuous in one direction i.e. if at first right direction, then left direction. This property of cotton fibre helps in spinning. Fig 4: show crimp in cotton fiber

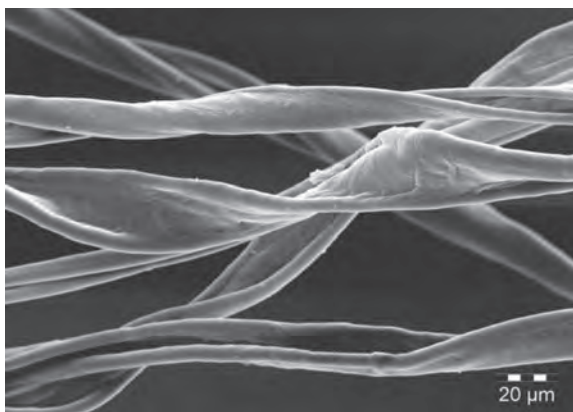

Fig 4- crimp in cotton fiber

شکل ۴ را با دقت نگاه کنید و سپس به سؤالات زیر پاسخ دهید.
الف) شکل سطح مقطع طولی لیف پنبه را تشریح کنید.
ب) شکل برش عرضی از این الیاف را در ۳ نقطه رسم کنید.
ج) روی شکل ۴، crimp یا تجعد (فرموج) را روی الیاف نشان دهید.
د) با توجه به مقیاس، عرض و طول تصویر و عرض و ضخامت چند نقطه الیاف پنبه را حساب کنید.

فعالیت
کلاسی ۲



A Sample For Natural Animal Fiber

SILK FIBER

SILK FIBER

Silk is a natural fiber and an animal fiber too. Silk fiber was firstly produced in China and then the production of silk worm extended to German, France, Turkey, Iran, Italy, India and Bangladesh.

Silk is an animal derived fiber produced from silk worm. It is the only natural fiber which is found in filament form. Fibroin is the main component of silk fiber. It is produced widely from a variety of silkworms such as the Cecropia moth from North America, the Tussah, Muga and Eri moths from India and the Anaphe moth from Africa. Commercially production is carried by the Mulberry Silk Moth, Bombyx Mori, the cocoon fed on mulberry.

Lifecycle silk worm

The natural of silkworm requires leaves of mulberry. The tiny eggs, left to hibernate by the previous year's moths, are warmed up gradually and hatch into baby caterpillars 10-14 days later. They eat ravenously, shedding their skins four times within four weeks, moulting as they outgrow each skin. After the last moult the silkworm is 7 to 10 cm long, fat and hairless. At this point their appetites are prodigious. After all this the silkworm stops eating and starts the production of its cocoon. Two modified salivary glands, on the caterpillar.s head produce a clear, sticky liquid which is then forced out through spinnerets and hardens on contact with the air to form a continuous filament. The caterpillar constructs the cocoon which is held together with Sericin, a gummy substance and gives distinctive shape. The process of the moth pushing its way out of the cocoon destroys the continuity of the thread. So, most moths are killed before they emerge. Now cocoons are ready for reeling. Each cocoon is made up of one extremely fine filament. Any remaining processes depend on the use to which the fiber is to be put but can include boiling off to remove the sericin, dyeing, finishing, weaving or knitting. The European Commission for the Promotion of Silk gives some interesting statistics. One acre of Mulberry yields around 4.5 tons of leaves which will produce around 200 kg of cocoons, giving 40 kg of raw silk.

Fig 5– show Lifecycle silk worm



Fig 5- Lifecycle Silk Worm

تمرین

تولید الیاف ابریشم را به زبان فارسی و در ۵ سطر خلاصه بنویسید.

SILK PROPERTIES

Silk Fiber Is very Much Thin: Silk is the thinnest amongst all the natural fibers. As it is so much thinner fiber, so silk can be used on any kind of fabric or clothes to be made.

Dyeing Property is good on Silk: The average dyeing on Silk works good.

Prints Well: Due to the fiber's flexibility and other convenience; the silk fabric can easily be printed without any problem.

Hand Washing & Dry Cleaning Is Possible: The washing fastness of silk fiber is good. One can wash the silk fabric by water and after washing the dry cleaning is possible too.

Silk creates static charges: The main problem of Silk fabric is that; silk creates static charges during wear or using any other purposes. In this case, silk fabric is little bit uncomfortable to

use as the traditional dresses. For this reason we see; Silk is only used to make Sharee which is occasionally used by the women.

Silk has no pilling problem: Silk fabric has no pilling problem.

Abrasion Resistance Is Good: Silk fabric is good resistant to the abrasion.

Light Fastness Is Poor: The main disadvantages of silk fiber is that; if you keep the silk fabric for the long time under the sun, then there might have a chance to lose the natural appearance of the silk fabric. So, it's better to stay away for prolonged exposure to sunlight.

Uses of silk in textile

Silk fiber is widely used to make different items. In apparel industry Silk is used for making Dresses, Blouses, Skirts, Jackets, Pants, Scarves and ties.

The clothes or apparels that are made from Silk are luxurious and simply expensive. Silk is widely used in Bangladesh & India to make the traditional silk Sharee that is worn in any kind of festivals or social programs. Fig 6 show silk used



Silk Yarn

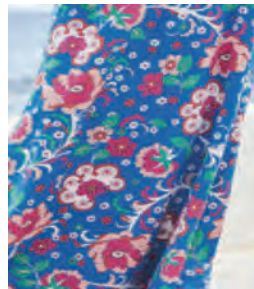

Silk Dress

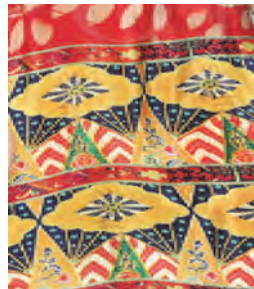

Silk Fabric

Fig 6- Silk Used

فعالیت

با رسم یک جدول خواص مهم ابریشم و کاربردهای آن را به انگلیسی بنویسید.

A Sample For Natural Synthetic Fiber

POLYESTER FIBER

POLYESTER FIBER

Polyester fibre is a widely used synthetic fibre. Basic raw materials for polyester fibre production are petroleum, coal, air & water. From those basic raw materials the Glycol monomer dihydric alcohol and Terephthalic acid are produced. Which are polymerized into an autoclave at high temperature and polyester chips are produced, which are melt spun. Fig 7 show polyester forms



Polyester Fiber



Polyester Dyed Yarn



Polyester Dyed Fabric



Polyester Printed Fabric

Fig 7– Show Polyester Forms

General properties of polyester textile

- 1** Length: Polyester fibre could be produced in filament form or staple form i.e. as we desire. Fibre length is controllable.
- 2** Fineness of polyester textile: Fineness of polyester fibre is also controllable.
- 3** X-Sectional shape: Normal cross sectional shape is round but it is also made triangular, elliptical or pentagonal. Normally it is white but could be of any color if color is added during spinning.
- 4** Strength: Normally tenacity varies from 4.5 to 5.0 gram per denier for the polyester textile. In case of high tenacity fibre it may be up to 8.0 gram per denier.
- 5** Extensibility: Extension at break varies from 20% to 30 %. Good recovery from extension. Due to good extension, strength and functional property polyester is widely used as sewing thread in the garment industries.
- 6** Resiliency: Polyester textile shows good resiliency property. It does not crease easily and any undue crease can be recovered easily.
- 7** Dimensional Stability: Polyester fibre is dimensionally stable. It could be heat-set at around 200 degree C. heat set polyester fibre does not shrink or extend.

- 8 Moisture Regain: Very low moisture ranges from 0 – 0.4%. Due to low moisture regain polyester fiber feels worm, easily cleaned, soils less.
- 9 Action of bleaching agents: It is not damaged by the action of bleaching agents.
- 10 Action of acid and alkali: It is unaffected by the action of acid and alkali.
- 11 Action of organic solvent: Polyester textile is unaffected by organic solvent, hence polyester fibre could be dry-cleaned.
- 12 Action of Sunlight & Heat: Polyester is unaffected by normal sunlight but prolong exposure to sunlight can reduce strength of polyester. Polyester fibre melts at 227 degree C to 242 Degree C. hence during ironing care should be taken to reduce the risk of damage. In contact to flame the polyester burns and melt when cold, the molten polymer forms hard bids.
- 13 Dye ability: Polyester fibre shows good dye ability at high temperature. Color fastness to washing and sunlight is also good. Disperse dyes are widely used for dyeing polyester fibre.
- 14 Biological Properties: Resistance to attack of mildew, moths and insects are good.
- 15 End use of Polyester textiles: Polyester fibre is widely used for apparels both 100% form and blended form with cotton, nylon, wool, rayon, acetate, etc fibres. Polyester textiles also used for making thermal underwear.

تمرین

■ با رسم جدولی در نرم افزار Word خواص ۱۵ گانه را با کاربرد آنها و تصاویر ایف مناسب پر کنید.

■ جای خالی را با توجه به متن پر کنید.

Color Fastness is good =.....
Protein regenerated fiber =.....
Organic Solvent on Polyester =.....
Very brilliant fibers =.....
For easy wearing =.....
Soak on the body of the sheep =.....
Man made very brilliant fibers =.....
On the sheep's skin =..... , ,
Suitable for blankets =.....

COTTON SPINNING

COTTON SPINNING

Spinning is the process of making yarns from the textile fiber is called spinning. Spinning is the twisting together of drawn out strands of fibers to form yarn.

Spinning has a few steps, these steps include: Blowroom - carding - drawframe - combing - roving - ring-frame - autoconer - openend.

Fig 8 show the sequence of spinning process:

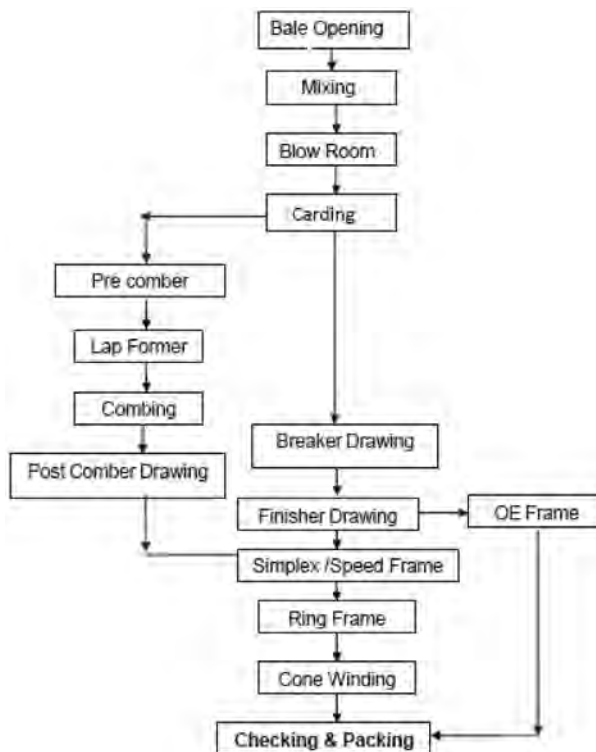

Fig 8- Show The Sequence Of Spinning Process:

Basic Textile Terms of Spinning

Fiber: The fundamental component used in making textile yarns and fabrics. Fibers are fine substances with a high ratio of length to thickness. They can be either natural (e.g. cotton, wool, silk etc.) or synthetic (e.g. polyester, nylon, acrylic etc.).

Blow room Lap: The Loose strand, roughly parallel, untwisted fiber sheet produced in blow room.

Chute feed system: It is a system of feeding small tufts of fibers directly from blow room to a series of cards, arranged in a circuit through pneumatic pipe. Sliver: The strand of loose, roughly parallel, untwisted fibers produced in Carding.

Roving: The soft strand of carded/combed fibres that has been twisted, attenuated, and freed of foreign matter, which is a feed material to spinning.

Yarn: A continuous strand of textile fibers that may be composed of endless filaments or shorter fibers twisted or otherwise held together.

Spinning: The process of making yarns from the textile fiber is called spinning. Spinning is the twisting together of drawn out strands of fibers to form yarn.

UV checking: Checking cones under Ultra Violet lights for any shade variations in cone.

Yarn Count /Sliver Hank

Yarn count is the numerical expression of yarn, which defines its fineness or coarseness. (Linear density).

Yarn count systems

Indirect system: English count (Ne), Worsted Count etc.

Higher the yarn number, finer the yarn.

Direct System: Tex, Denier

I.e. Higher the yarn number, Coarser the yarn.

Similarly numerical expression of fineness or coarseness of Lap, sliver & roving are called Hank.

Note: English (Ne) count system is commonly followed in India.

English Count: No. of Hanks of length 840 yds weighing in 1 pound

1yds: 1.9144 mtrs

1lbs: 0.453 Kgs.

e.g. 40s Ne = 40 hanks of 840 yds weighs 1 lbs.

20s Ne = 20 hanks of 840 yds weighs 1 lbs.

تمرین

با انجام محاسبات لازم جاهای خالی را پر کنید.

..... yds =17.45 mtrs

21.44 yds = mtr

5 lbs = Kgs.

..... lbs = 4.756 Kgs.

..... Ne = 32 hanks of 840 yds weighs 1 lbs.

10s Ne = hanks of 840 yds weighs 1 lbs.

تمرین

در باره هر واژه یک سطر مطلب به فارسی بنویسید و سپس آن را به انگلیسی ترجمه کنید.

Fiber:

Blow room Lap:

Chute feed system:

Carding sliver:

Draw fram sliver:

Combed lap:

Combed sliver:

Roving:

Yarn:

Spinning:

UV checking:

Yarn Count/Sliver Hank :

Yarn count systems :

تمرین

جدول ۱ را ترجمه کنید و سپس درباره آن یک صفحه به فارسی بنویسید.

Table1 spinning data

Table 1- Material Flow in Spinnig

WORK	MACHINE	IN PUT MATERIAL	OUT PUT MATERIAL	PACKAGE FORM	COUNT OF PRODUCT
Opening & Cleaning	Blow room machines	Raw cotton	Lap or chute feed	-	Gr/ m ²
Carding	Carding machine	Lap or chute feed	Card sliver	Carded slivers in cans	Gr/m or grin / yd
Pre comber drawing	Breaker draw frame	Carded sliver	Drawn sliver	Drawn slivers in cans	Gr/m or grin / yd
Lap Formation	Super lap or lap former	Drawn slivers	Lap	Laps in spools	Gr/m
Combing	Comber	Lap	Combed Sliver	Combed sliver in cans	Gr/m or grin / yd
Post comber drawing	Finisher draw frame	Combed sliver	Drawn sliver	Post comber draw frame slivers in cans	Gr/m or grin / yd
Roving	Speed Frame	Post comber Draw frame sliver	Roving	Roving bobbin	Hank 480yd's in 1lb
Spinning	Ring frame	Roving	Ring-spun yarn	Spinning cops	Ne
Post-spinning processes	Winding	Yarn in spinning cops	Yarn	Cone, Cheese & Hank as required	Ne

A Sample For Spinning Machinery

FLAYER

FLAYER

Fig 9 :Shows the flayer machine.

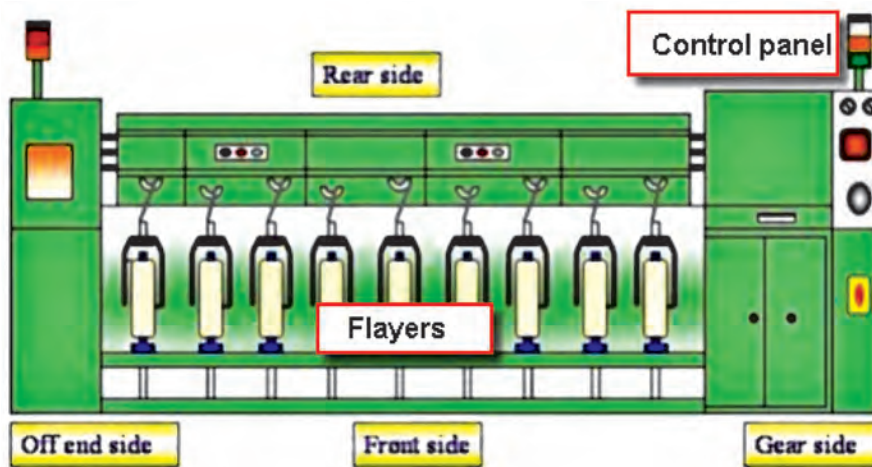

Fig 9- Shows The Flayer Machine

Creeling:

Draw frame slivers are fed to the roving frame in large cans. The slivers are guided through separators and then over the guide rollers and tension rollers. The slivers then pass through the drafting rollers.

Drafting:

To draft the sliver to reduce weight per unit length. In the drafting zone pneumatic pressure is applied over the drafting rollers and the speed difference between the drafting rollers, drafts the sliver to desired hank.

Twisting:

The drafted slivers delivered are too thin to hold themselves together and slight twist is needed to strengthen the roving to prevent breakage during next processing. The drafted strands of fibres are passed from Drafting zone to flyers for twisting.

Winding:

The flyers impart twist to the fibre strands and make the roving strong enough to be wound on the bobbin and to be processed in Ring Frame

Building: The up & down traversing of bobbin rail builds up the bobbin to make conical or taper shape of the bobbin

Doffing:

When the roving bobbins become full the machine is stopped and doffing takes place to remove full bobbins and to fix empty bobbins with required length of roving manually wound on the empty bobbins through Flyers for continues working.

Display panel:

It displays various operating machine parameters like speed, production etc. Understand the details in the display panel and work accordingly

Roving Break Stop mechanism & Sliver Break Stop mechanism:

Photo electrical sliver and roving break stop mechanism.

Whenever sliver or roving breaks due to any reason machine stops.

Operating Speed Frame Machine

- Creel the required number of sliver cans and draw the slivers forward.
- Take the slivers through guide rollers and feed to drafting zone.
- Operate the control switches for inching, starting and stopping the Speed frame.
- By inching feed the material and start running.
- Follow the different signal lamps & stop motions used in machines.
- Piece the sliver during breakage
- Piece the roving during breakage
- Support the doffing team and doff the full Roving bobbins.
- View the display panel and identify the reasons for machine stoppages if any.
- Inform the supervisor and maintenance in charge in case of any break-downs
- Support for carrying out maintenance activities.
- Carryout cleaning activities in creeling, drafting, and in Flyer.
- Remove the waste while attending breakage/creeling and put them in appropriate waste collection bins.
- Always keep Speed frame area clean

تمرین

در زیر هر شکل یکی از چهار عملیاتی که در صفحه قبل آمده است را به انگلیسی و فارسی بنویسید.



Fig 10 - Flayer machine

تمرین

زیر هر شکل نام و یا نام عملیات موردنظر را به انگلیسی بنویسید.

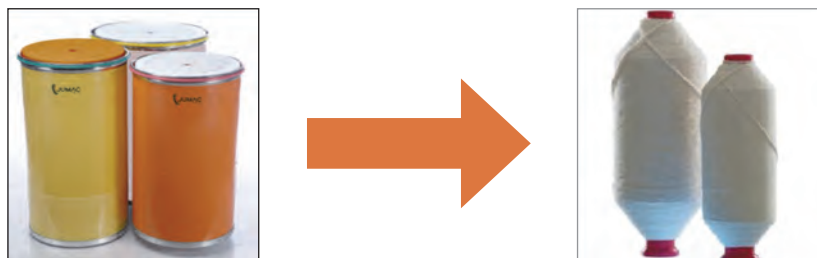

Fig 11 - Spinning Product

A Sample Of Spinning Machinery

RING FRAME

RING MACHINE

Functions of ring frame machine

- To produce required count of yarn from the supplied roving by drafting.
- To insert sufficient amount of twist to the yarn to impart strength.
- To wind the yarn onto the bobbin.
- To build the yarn package properly

FIG 12 SHOW A RING FRME MACHINE

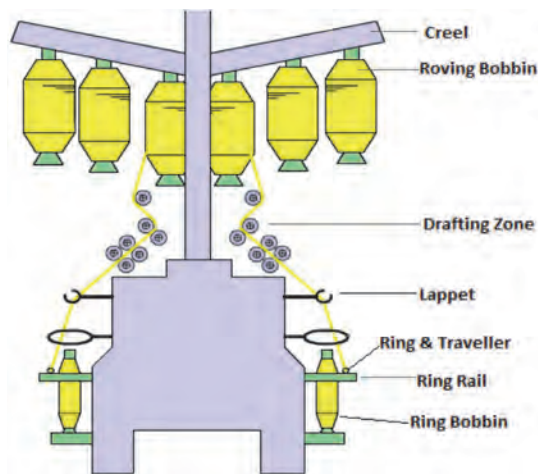

Fig 12 - Ring Frame Machine

Creeling:

Roving is fed to the Ring frame from roving bobbin held by creels. For all the spindles roving bobbin are creeled on the machine. The roving is guided and passed through trumpet. The roving then passes through the drafting rollers.

Drafting:

To draft the roving to reduce weight per unit length. The Drafting zone in Ring Frame attenuates the roving to desired fineness by imparting required draft to the roving by top arm pressure and the speed variations in the Bottom rollers of drafting zone.

Ring & Traveller:

The ring guides the circular run off the traveller. The drafted strands of fibres as they are delivered by the front rollers are given twist to produce a yarn. The Ring and travellers enable to Wind the yarn onto the bobbin & maintain winding tension of the yarn. It acts as a second guide for the yarn on the way to be wound on the bobbin.

Doffing:

To replace with empty bobbins when the Ring Bobbins become full.

Display Panel:

It displays various operating machine parameters like speed, production, Count of yarn etc. Understand the details in the display panel and work accordingly

تمرین

با توجه به متون بالا، عملکردی که در تصویر می بینید را به فارسی و انگلیسی بنویسید.



Fig 13 - Spinning Process

تمرین

نام مواد و عملیات انجام شده را در شکل زیر بنویسید.



Fig 14 - Spinning Process and Product

Non Technical Competency

Handing over the Shift

- Properly hand over the shift to the incoming shift operator.
- Provide the details regarding the lot being packed, count of yarn, colour coding of cones for different counts being packed, weight details etc.
- Provide information about defective cones/ adas cones stored for rework/rejection
- Inform about the packing materials used in the shift
- Inform about count labels being used to stick in the cones
- Check for the cleanliness of the work place.
- Get clearance from the incoming counterpart before leaving the work spot, in case if the next shift operators do not come, report to shift supervisor.
- Report to the shift supervisor about the defects in cones / packing / safety issues/ any other issues faced in the shift and leave the department only after getting concurrence for the same from supervisors.

Importance of health & safety

- Follow the safety work instructions
- Follow safe work practices like in UV checking, handling strapping machine, moving the packed carton/bags
- Always use head cap, hand Gloves & Nose mask in the work spot.
- Take action based on instructions in the event of fire, emergencies or accidents, and participate in mock drills/ evacuation procedures organized at the workplace as per the organization procedures.

The classification of the weaving machinery

Hand looms: This kind of loom still used relatively large quantities for the production of all types of fabrics in the less-developed countries.

Non -automatic power loom: These machines are being used in ever-decreasing numbers, especially in the developed countries, but they seem likely to retain a certain usefulness in the production of specialist fabrics.

Conventional Automatic Loom: The machines that gained world-wide popularity because of their advantages of versatility and relative cheapness.

Circular Loom: They are strictly limited in their applications, but they do achieve the ideal of high weft-insertion rates from relatively low shuttle speeds because insertion of the weft is continuous.

تمرین

با توجه به شکل ۱۵ نام هر ماشین بافندگی را زیر آن بنویسید.

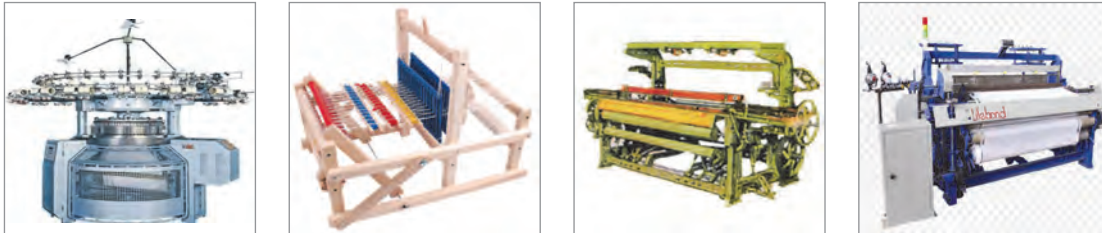
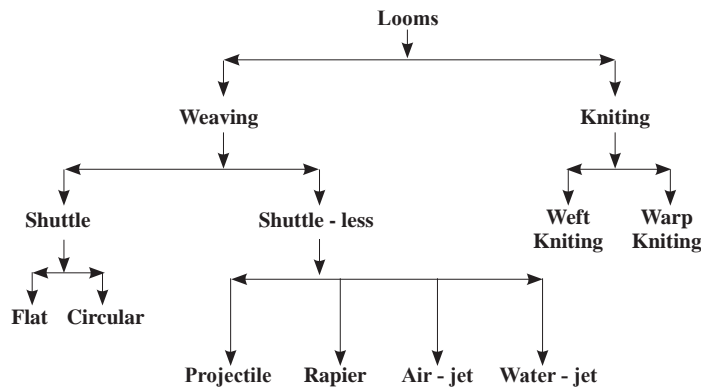

Fig 15- Weaving And Knitting Machine

Weaving Machinery

Weaving is one of the processes that required in textile in terms of producing a fabric. Table 2: show types of Weaving machine (LOOMS)

Table 2- types of Weaving machine (LOOMS)



From the fiber then become a yarn through some other process, weaving is a process of interlacing two types of yarn known as warp or ends (run parallel to the weaving machine known as loom) and weft or filling yarn (run perpendicular to the loom) to produce a rigid fabric. Weaving machines make fabrics. This fabric Have weft and warp

Fig 16 show a fabric and weft & warp.

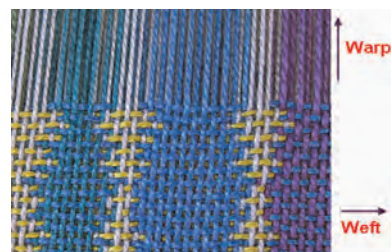

Fig 16- Warp And Weft Yarn In Fabric

What Is Knitting?

Knitting is the process of manufacturing fabric by transforming continuous strands of yarn into a series of interlocking loops, each row of such loops hanging from the one immediately preceding it. The basic element of knit fabric structure is the loop intermeshed with the loop adjacent to it on both sides and above and below it.

Classification of Knitting:

- 1 Warp Knitting.
- 2 Weft Knitting.

Weft Knitting: In a weft knitted structure, a horizontal row of loop can be made using one thread and the threads run in the horizontal direction. Fig 17 knitting fabric



Weft Knitting Map



Hand Weaving Weft Knitting



Weft Knitting

Fig 17 - Knitting Fabric

Weft Knitting Machine

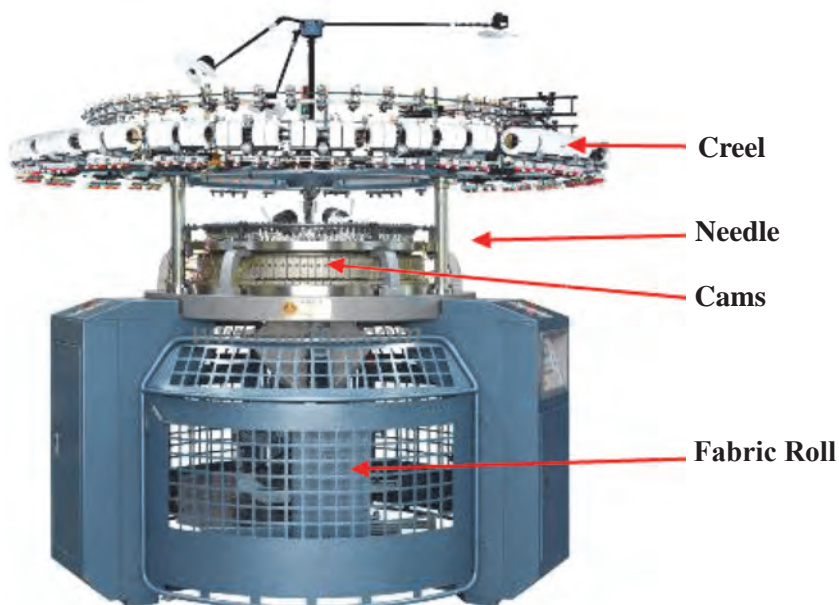

Fig 18 - Show A Knitting Machine

A knitting machine have this parts:

Creel: Creel is a part of a knitting machine. Here yarn package are stored and ready to feed in the machine.

VDQ Pulley: It is a very important part of the machine. It controls the quality of the product. Altering the position of the tension pulley changes the G.S.M. of the fabric.

If pulley moves towards the positive direction then the G.S.M. will decrease. And in the reverse direction G.S.M will increase.

Pulley Belt: It controls the rotation of the MPF wheel.

Brush: Its clean the pulley belt.

Tension Disk: It confronts the tension of the supply yarn.

Inlet and Outlet Stop Motion: It is an important part of the machine. It stops the machine instantly when a yarn breaks.

Yarn Guide: It helps the yarn to feed in the feeder.

MPF: It is Mamenger positive feed. It is also an important part of the machine. It's give positive feed to the machine

Feeder Ring: It is a ring. Where all feeders are pleased together.

Disk Drum: Use in jacquard machine to produce various types of design.

Pattern Wheel: Pattern Wheel use in Pai Lung and Auto Stripe machine because of that that help to produce various types of design and stripe.

Feeder: Feeder is help yarn to feed in to the machine.

Needle Track: Where all Needles is placed together in a decent design.

Needle: It is a principal element of the knitting machine. Its help the yarn to create a loop. And by this way fabric are produce. Prior to yarn feeding the needle is raised to clear the old loop from the hook, and received the new loop above it on needle stem. The new loop is then enclosed in the needle hook as the needle starts to descend.

Sinker: It is most important element of the machine. Its help to loop forming, knocking over and holding down the loop.

Sinker Ring: Sinker ring is a ring. Where all sinkers are pleased together.

Cam Box: Where the cam are set horizontally.

Cam: Cam is device s which converts the rotary machine drive in to a suitable reciprocating action for the needles and other elements.

Cylinder: Needle track are situated hear.

Cylinder Balancer: It helps the cylinder to set in a proper alignment. Fig show a few process

با توجه به متن صفحه قبل زیر هر شکل نام مناسب را به انگلیسی و فارسی بنویسید.



Fig 19 – Knitting Process

Warp Knitting: In a warp knitted structure, each loop in the horizontal direction is made from a different thread and the number of threads are used to produce such a fabric is at least equal to the no of loops in a horizontal row. Fig 20 warp knitting fabric



Warp Knitting Map

Warp Knitting Fabric

Mesh Fabric

Fig 20 – Warp Knitting Fabric

Weaving machine code name

The machine name is composed of several codes.

Table 3- you will see several of codes

Machine type code	Machine type code
Terry Air-Jet Weaving Machine DORNIER ServoTerry®	DORNIER High Performance Rapier Weaving Machine P1
ATSF 8/S 260 G	PTS 12/J 190 C
Number of filling colors	Number of filling colors
Shed formation	Shed formation
S: Dobby machine	S: dobbie
J: Jacquard machine	E: positive cam motion
Nominal width in cm	J: Jacquard machine
C: CompactDrive	Nominal width cm
D: DirectDrive	C: CompactDrive
G: Separate drives DORNIER SyncroDrive®	

تمرین

با توجه به جدول کد نام ماشین‌های بافندگی، ماشین‌های بافندگی با کدهای زیر را تفسیر کنید.

- No:1- weaving machine code ATSF 4/S 180 C
- No:2- weaving machine code ATSF 6/J 240 D
- No: 3- weaving machine code PTS 10/E 150 C
- No: 4- weaving machine code PTS 8/S 170 C
- No: 5- weaving machine code PTS 12/J 140 C

DYEING CATALOGS

INTRODUCTION

This pattern card illustrates the Procion H-E/H- EXL dyes and support Procion H dyes which are Particularly Suitable for the exhaust dyeing of cellulose and the cellulose component of blends with synthetic fibres, in both piece and yarn form on all types of batchwise dyeing equipment.

PHYSICSL FORM

Procion H-E/H- EXL dyes are available in a non-dusty granular form to meet the requirements of Health and Safety regulations pertaining to the handling of reactive dyes.

Stability

Procion H-E/H-EXL dyes. Grains brands, possess good storage stability. It is recommended that containers are always closed tightly and stored in cool, dry conditions. Hot humid conditions promote deterioration.

Dissolving

Either

(a) paste the dye with water and dissolve by adding water at a temperature not higher than 80°C (at pH7)

or

(b) feed the dye powder steadily into vortex created by a high speed stirrer running in water at a temperature not higher than 80°C (at pH7)

Do not attempt to dissolve **Procion H-E/H-EXL** dyes together with dyeing assistants or auxiliary products. Where the solubility limit of a dye is exceeded, for example when applying heavy shades by padding, the addition of up to a maximum of 200 g/l urea may be necessary. Dry mix the urea with the dye before dissolving.

WATER QUALITY AND THE USE OF SEQUESTRANTS

Procion dyes should be applied and washed off in soft water. Small amounts of calcium and magnesium normally above 100 ppm, may cause restraining or precipitation of dye which may lead to reduced yields, unevenness or reduced fastness. Traces of heavy metals, over 2 ppm copper or 10 ppm iron, should also be avoided as they may affect the shade of certain dyes. The effect of copper and iron on the shade of **Procion** dyes is given in the pattern/data pages.

It is also advisable to use sequestering agents during preparation, to remove any traces of calcium and magnesium salts present in raw cotton.

The pH of the water should be in the range 6-7.

As in the case of hard water, the recommended sequestering agent to use is sodium hexametaphosphate.

SALT QUALITY

The common salt (sodium chloride) or Glauber's salt (sodium sulphate) used in dyeing should be checked for alkali contamination and neutralised if necessary. In addition, where common salt has been derived from evaporated sea water, attention must be paid to sequestering the calcium and magnesium present. If this is not done, gross precipitation may occur when the alkali is added for the fixation stage.

FABRIC PREPARATION

The cellulose piece or yarn should be prepared by one of the methods outlined below. The choice of preparation sequence will depend upon the cleanliness of the substrate and the brightness of the shades to be dyed.

Surface abrasion of fabrics can occur in jet-nad winch. dyeing machines due to fibre to metal friction. This can be reduced by the addition of a lubricant to the preparation, dyeing and finishing baths. It is important that the lubricant is stable to high concentrations of salt and to alkali and does not suppress dyd yield.

Depsoluge ACA is such a product and also assists the emulsification of oils and waxes.

When woven goods are to be dyed an adequate desizing must be given. This should be followed by scouring or bleaching (if required) as described below.

Scouring

For all but the brightest shades, the following scouring treatment may be given as preparation to both cotton and viscose rayon:

Soda ash	2 g/ l
Lenetol WLF 125 (werring agent)	1g/ l
Sequestrant	1g/ l

Treat for 20 minutes at the boil.

Treatment should be followed by rinsing the goods thoroughly with hot and cold water to remove residues of preparation.

Bleaching

For bright shades, or to remove impurities in the cotton, a combined scour/ bleach may be given before dyeing. This combined treatment is usually carried out using a peroxygen compound and a typical recipe would be:

Lenetol PS (bleaching assisteant)	1-2 g/ l
Caustic soda (100%)	1-2 g/ l
Hydrogen peroxide (30%)	2-4 ml/ l

Treat for 30-60 minutes at 95°C

In machines where the above recipe causes too much foam, the alternative recommendation is:

Stabiliser CB	1g/l
Caustic soda (100%)	1-2 g/ l
Hydrogen peroxide (30%)	2-4 ml/ l
Lenetol WLF 125	1g/l

Dyeing curves

The curves includen in the pattern pages illustrate the dyeing behaviour of the dyes on bleached cotton applied under the following conditions:

Depth of shade: 1%

Liquor ratio 20:1

Time: 30 minutes in salt, 60 minutes in soda ash

Temperature: 80°C

Common salt: 60g/l

Soda ash: 20g/l

The curve illustrating the effect of temperature show the behaviour of a 2% dyeing applied at 20:1 LR. The histogram illustrating the effect of liquor ratio refers to the behaviour of a 1% dyeing applied at 80°C.

Procion H-E and **H-EXL** dyes are generally easy to use and such differences as exist between dyes do not preclude their use in mixtures.

Shade Illustrations

The dyeings shown in this card were prepared on the winch at 20:1 liquor ratio on scour-bleached cotton fabric.

Ionic copper or iron catalyses the decomposition of hydrogen peroxide which can damage the cotton, particularly if it is localised. Lenetol PS and Stabiliser CB are efficient in removing copper and iron and usually, therefore, an addition of EDTA sequestrant will not be needed.

Dyeing methods

Method 1. Portionwise addition of salt

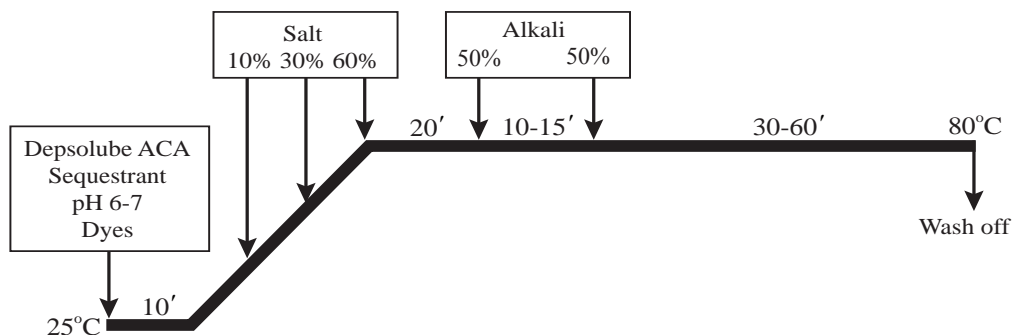

This process is recommended for non-circulation machine

This process is recommended for non-circulating liquor machinery employing manual addition of electrolyte to control the rate of exhaustion. Suitable for all depths of shade.

- Prepare the substrate
- Fill the machine from the cold water supply and add the pre-dissolved dyes, lubricant (Depsolube ACA, 1g/l), sequestrant and anti-reduction agent (Matexil PA-L Liquid, 3g/l)- Check pH
- Dye for 10 minutes to ensure an even dye distribution
- Add the salt in three portions (10%, 30% and 60%) during the period of raising the temperature to 80°C
- Dye for 20 minutes at 80°C after the last salt addition
- Add the alkali, If soda ash alone is used as alkali this should be added over 10 minutes. If a mixture of soda ash and caustic soda is used, the premixture Should be added over 15 minutes.

- (g) Dye for a further 30-60 minutes at 80°C depending upon depth of shade;
- (h) Drop the bath and wash off

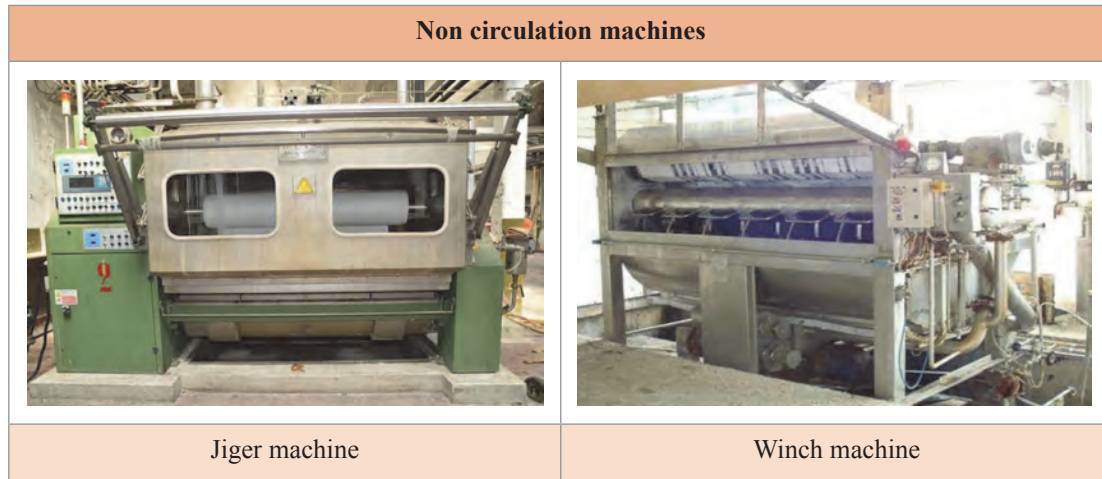
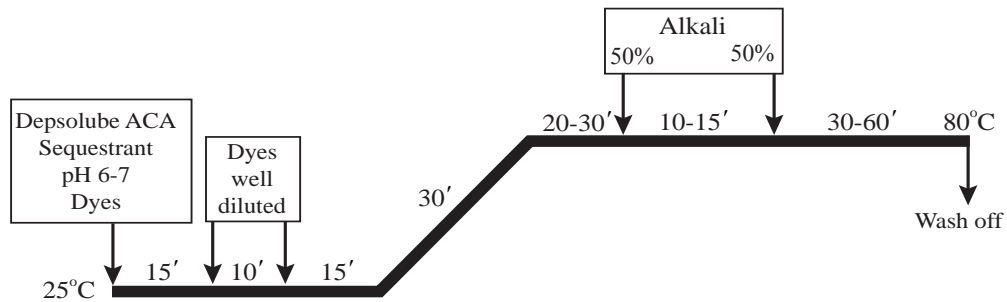

Fig 21 Non circulation machines

Method 2. Add salt in start



This method is suitable for machines with liquor circulation and for dyeing all medium to heavy depths of shades. All of the salt may be added at the start thereby reducing handling and saving time.

- (a) Prepare the substrate
- (b) Add all the salt to the bath set with water from the cold water supply, add lubricant (Depsolube ACA, 1g/l), sequestrant and anti - reduction agent (Matexil PA-L Liquid , 3g/l) - Check pH
- (c) Circulate for 15 minutes to allow the salt to be uniformly distributed (in package and beam - dyeing machines 5 to 10 minutes is sufficient)
- (d) Add the pre - dissolved dyes over 10 minutes
- (e) Dye for 15 minutes (this stage may be omitted in package- and beam- dyeing machines)
- (f) Raise the temperature to 80°C over 30 minutes
- (g) Dye for 20- 30 minutes at 80°C

- (h) Add the alkali. If soda ash alone is used as alkali this should be added over 10 minutes, If a mixture of soda ash and caustic soda is used, the premixture should be added over 15 minutes.
- (i) Dye for a further 30-60 minutes at 80°C depending upon depth of shade; (Increase dyeing duration Increase color depth)
- (j) Drop the bath and wash off

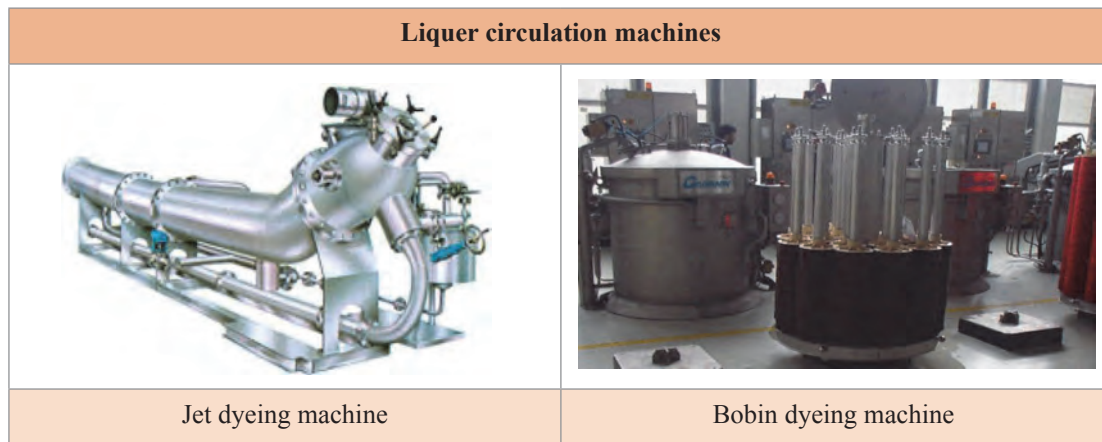

Fig 22 Liquor circulation machines

Table 4- Dye technical data

KEY TO ABBREVIATIONS	
the following abbreviations have been used in the pattern/data pages.	
Bl	= bluer
Br	= brighter
D	= duller
G	= greener
L	= little
M	= much
R	= redder
T	= trace
W	= weaker
Y	= yellower
Str	= stronger
●●●	= highly recommended
●●	= recommended
●	= limited interest
O	= not recommended
DMDHEU	= dimethylol dihydroxy ethylene urea
EDTA	= ethylene diamine tetra acetic acid (type of sequestering agent)
MgCl ₂	= magnesium chloride catalyst
Zn(NO ₃) ₂	= zins nitrate catalyst
LR	= liquor ratio
TL84	= Philips TL84/P15 fluorescent light
min	= minute(s)
sec	= second(s)
(c)	= staining of cotton
(v)	= staining of viscose rayon
(w)	= staining of wool
(n)	= staining of nylon
Dischargeability	
A	= dischargeable to a good white
B	= dischargeable to a moderate white
C	= suitable for coloured discharges only
D	= not suitable for either discharge or discharge/resist purposes

تمرین

با توجه به جدول ۴ هر کدام از رنگ‌های زیر را تفسیر کنید

- | | |
|---|----------|
| 1- Dispersol Fast Yellow T5G Liquid | 1- |
| 2- Duranol Brilliant Yellow T4G
Power Fine | 2- |
| 3- Dispersol Fast Yellow T Liquid | 3- |
| 4- Duranol Brilliant Yellow TRN
Power Fine | 4- |
| 5- Dispersol Fast Yellow T3R Liquid | 5- |
| 6- Dispersol Fast Yellow T4R Liquid | 6- |
| 7- Duranol Brilliant Orange TG Power
Fine | 7- |
| 8- Dispersol Fast Red T3B Grains | 8- |

با توجه به جدول ۴ کاتالوگ زیر را تفسیر کنید.

Dispersol Navy C-4R Liquid

Fastness Properties						
Test	Straight			After glyoxal resin		
	Effect on shade	Stain		Effect on shade	Stain	
		c	n		c	n
ISO 3 Wash	5	5	4-5	5	5	5
ISO 4 Wash	5	5	4	5	5	4
Hypochlorite Wash	4-5	5	4-5	5	5	4-5
Chlorinated Water	4-5			4-5		
Perspiration (pH 5-5)	5	4-5	4-5	5	4-5	4-5
Tartaric acid Spot	5			5		
Sodium carbonate Spot	4-5			4-5		
Gas Fumes	5			5		
Light (Xenon arc)	pale	4		4		
	medium	4-5		5-6		
	heavy	4-5		5-6		
Hot Pressing	Dry	Immediate	4 R		5	
		After 4h	5		5	
	Wet	5		5		
Change in artificial light		R			R	
Heat Fastness	Intermediate	5	5	4-5 (p)		
	Severe	4-5	3-4	2-3 (p)		
Effect of glyoxal resin	5					

Notes c=cotton, n=bulked nylon 6.6, p=polyester

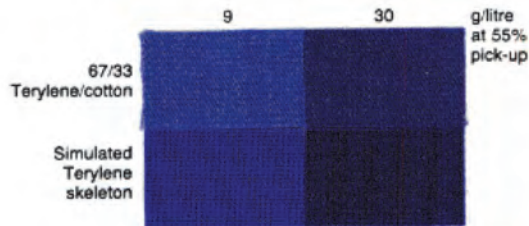

ارزشیابی

ارزشیابی در این درس براساس شایستگی است. برای هر پودمان ۱ نمره مستمر (از ۵ نمره) و ۱ نمره شایستگی پودمان (نمرات ۱، ۲ یا ۳) با توجه به استانداردهای عملکرد جداول ذیل برای هر هنرجو ثبت می‌گردد.

جدول ارزشیابی پودمان ۵- کسب اطلاعات فنی صنایع نساجی

نمره	استاندارد (شاخص‌ها، داوری، نمره‌دهی)	نتایج	استاندارد عملکرد (کیفیت)	تکالیف عملکردی (شایستگی‌ها)	عنوان پودمان فصل
۳	تشریح دستورات و کاربرد به‌موقع و تحلیل پاسخ‌ها	بالاتر از حد انتظار	توانایی استفاده از کاتالوگ مواد اولیه و ماشین‌ها برای کار کردن صحیح با آنها	Spining & Weaving	کسب اطلاعات فنی
۲	دانستن کلمه‌ها و درک مفهوم دستورات	در حد انتظار		Dyeing & Printing & Finishing	
۱	دانستن کلمه‌های انگلیسی مرتبط با نساجی و غیر مرتبط	پایین‌تر از حد انتظار			
نمره مستمر از ۵					
نمره شایستگی پودمان از ۳					
نمره پودمان از ۲۰					

- ۱ برنامه درسی دانش فنی تخصصی رشته صنایع نساجی، دفتر تألیف کتاب‌های درسی فنی و حرفه‌ای و کاردانش، ۱۳۹۶
- ۲ یکتا مهدی، فرش ماشینی، چاپ کارآفرینان خلاق امیرکبیر، ۱۳۸۵.
- ۳ پژمان محمد، کف پوش‌های ماشینی، نشر مبعث، ۱۳۸۹
- ۴ دیاری بیدگلی، منصور، فرش ماشینی، انتشارات دانشگاه آزاد اسلامی کاشان، ۱۳۹۵
- ۵ توسلی محمد سعید، رنجبر پازوکی رضا، فرش و کف پوش‌های ماشینی، نشر دانشگاه امیرکبیر، ۱۳۶۷
- ۶ هاشمی، حبیبی، فناوری نانو در نساجی، نشر جهاد دانشگاهی امیرکبیر، ۱۳۹۲
- ۷ فاطمی، نانو تکنولوژی در صنعت نساجی، نشر کیفیت، ۱۳۹۵
- ۸ آذرمی، اشجاران، نانو الیاف و نانو تکنولوژی در نساجی، نشر دانشگاه آزاد اسلامی یادگار امام تهران، ۱۳۹۴
- ۹ سایت شبکه نانو نساجی nanotexnet.ir و ستاد ویژه توسعه فناوری نانو nano.ir و ...
- ۱۰ بهرامی، گودرز، منسوجات فنی، نشر دانشگاه صنعتی امیرکبیر، ۱۳۹۴
- ۱۱ ورسه‌ای، میرخانی، علی بابایی، حسینی شکرایی، منسوجات صنعتی، نشر جهاد دانشگاهی امیرکبیر، ۱۳۹۵
- ۱۲ کیوانفرد، تصفیه پساب صنایع نساجی، نشر کنکاش، ۱۳۹۵
- ۱۳ سازمان بهره‌وری انرژی ایران، گزارش مدیریت مصرف انرژی در صنایع نساجی، ۱۳۹۴
- ۱۴ رنگرزی، رشته صنایع نساجی، کمال‌الدین قرنجیک، علی ابراهیمی معتمد، صابر رستاک، چاپ و نشر کتاب‌های درسی ایران، ۱۳۸۴
- ۱۵ نجفی کوتنانی، آصفی پور، حکمتی؛ ولی پور، رنگرزی الیاف مصنوعی و مخلوط، نشر جهاد دانشگاهی امیرکبیر، ۱۳۸۸
- ۱۶ نجفی کوتنانی، رشیدی، تکنیک‌های چاپ در شیمی نساجی، نشر جهاد دانشگاهی امیرکبیر، ۱۳۹۲
- ۱۷ سید صدر، دایرةالمعارف نساجی و حرفِ مربوط به آن، انتشارات سیمای دانش، ۱۳۹۳
- ۱۸ H.R.Mattila, Intelligent Textiles and Clothing, 2006
- ۱۹ Celanese Acetat, Complete textile Glossary, Calenese Acetate LLC Pub., 2001
- ۲۰ A.R.Horrocks and S.C.Anand. Handbook of Technical Textiles, 2005
- ۲۱ TEXTILES COMMITTEE (Government of India, Ministry of Textiles) Spining proceses 2016
- ۲۲ TEXTILES COMMITTEE (Government of India, Ministry of Textiles) Weaving proceses 2016





هنرآموزان محترم، هنرجویان عزیز و اولیای آمان می‌توانند نظرهای اصلاحی خود را درباره مطالب این کتاب از طریق نامه

برنشانی تهران - صندوق پستی ۴۸۷۴ / ۱۵۸۷۵ - گروه درسی مربوط و یا پیام نگار tvoccd@roshd.ir ارسال نمایند.

وب‌گاه: tvoccd.oerp.ir

دفترتالیف کتاب‌های درسی فنی و حرفه‌ای و کاروازش

