



پودمان ۵

کسب اطلاعات فنی

## واحد یادگیری ۹

### کسب اطلاعات فنی در معماری داخلی

#### آیا تا به حال پی برده‌اید

- کسب اطلاعات فنی در کارهای اجرایی معماری داخلی چه کاربردی دارد؟
- چگونه می‌توان از اطلاعات فنی دفترچه‌های راهنما استفاده کرد؟
- ضرورت و اهمیت انجام کارهای اجرایی طبق مشخصات فنی دفترچه‌های راهنما چیست؟

#### استاندارد عملکرد

پس از پایان این واحد یادگیری هنرجو قادر خواهد بود:

- 1) اطلاعات فنی و دستورالعمل‌های اجرایی در کارهای معماری داخلی را از دفترچه‌های راهنما و متون به زبان انگلیسی استخراج کرده و به کار بگیرد.

#### مقدمه

به منظور استفاده از فناوری‌های نوین بین‌المللی و آگاهی از اجرای استاندارد فعالیت‌های اجرایی معماری داخلی ضروری است که هنرجویان بتوانند ضمن فراگیری واژه‌های اصلی در زمینه کاری خود از متون به زبان انگلیسی استفاده کرده و اطلاعات فنی خود را به روز کنند. از این رو در این واحد یادگیری به سه متن تخصصی دربارهٔ اجرای نازک‌کاری در بخش‌های کف، دیوار و سقف پرداخته شده است.

## PART 1

### LAMINATE FLOORING INSTALLATION INSTRUCTIONS



#### GENERAL GUIDELINES

- Laminate flooring is installed using a patented glueless locking mechanism. Because this is a floating floor system, laminate flooring should not be nailed or glued to the subfloor.
- The floor should not be installed directly against any fixed, vertical objects (including wall, staircases, fixtures, etc.); Allow a minimum of 5/16" (8mm) expansion space around the perimeter of the room and any fixed objects such as posts. Use spacers included in the recommended laminate flooring kit to achieve uniform space around fixed objects.
  - Rooms measuring wider or longer than 30' (9m) require the use of T-moldings to allow for normal expansion and contraction of the floor.
  - Be sure to stagger boards by a minimum of 12" (300mm).
  - Laminate flooring should not be installed in rooms where the relative humidity exceeds 70%.

## GENERAL REQUIREMENTS FOR ALL TYPES OF SUBFLOORING

Laminate flooring can be installed over most floors such as vinyl, tile and sheet floors. Substrates should be structurally sound and immobile. Before installing flooring, ensure that the subfloor is leveled within 3/16" in 10' (2mm in 2m). Irregularities in the subfloor should be smoothed using a hydraulic cement base patching and leveling compound. Suspended wood subfloors should have a minimum of 18" (45cm) of well-ventilated air space above the ground.



### Concrete:

- New concrete subflooring should be cured for at least 90 days prior to installation.
- Install 0.008" (0.20mm) age-resistant, non-permeable polyethylene vapor barrier over the concrete subfloor. Seams must be taped using adhesive tape such as duct tape. The vapor barrier should be installed up the wall by 1" (25mm).

### Carpeting:

- Remove deep pile carpeting and padding prior to installation of laminate flooring.
- Laminate flooring can be installed over industrial direct glue-down carpeting installed over wood subfloors without padding.
- Carpet installed over concrete must be removed. See instructions for installation over a concrete subfloor.

### Radiant Heating Systems:

- Laminate flooring can be installed on under-floor radiant heating systems if the heating element is installed into wood or concrete subfloors.
- Lower heating system to 60 °F (16 °C) for 1 week before installation.
- After installation, slowly increase the temperature in increments of 10 °F (6 °C) per hour.
- Surface temperature must not exceed 85 °F (28 °C).

## CONDITIONING

It is important to allow laminate flooring to acclimate to the room temperature where it is to be installed by placing the packaged flooring flat in the room for a minimum of 48 hours

prior to installation. Do not remove the plastic wrapping. Be sure that the room temperature is in the range of 65-75 °F (18-20 °C).

## ROOM PREPARATION

- 1 Determine which direction to lay the planks. If installing in narrow hallways or small rooms, the area will appear larger if flooring is laid parallel to the longest wall.
- 2 Remove all existing moldings.
- 3 If room has electric baseboard heaters, leave a minimum of 1/2" (12.5mm) between the surface of the flooring and the bottom of the heaters, allowing heat to circulate.
- 4 Check door clearances, making necessary adjustments before laying the flooring. Door moldings (jambs) should be undercut to accommodate the thickness of the flooring and foam underlayment.
- 5 Install underlayment per manufacturer's instructions (for flooring without attached underlayment).

### Site and Material Preparation

#### Site and Material Preparation

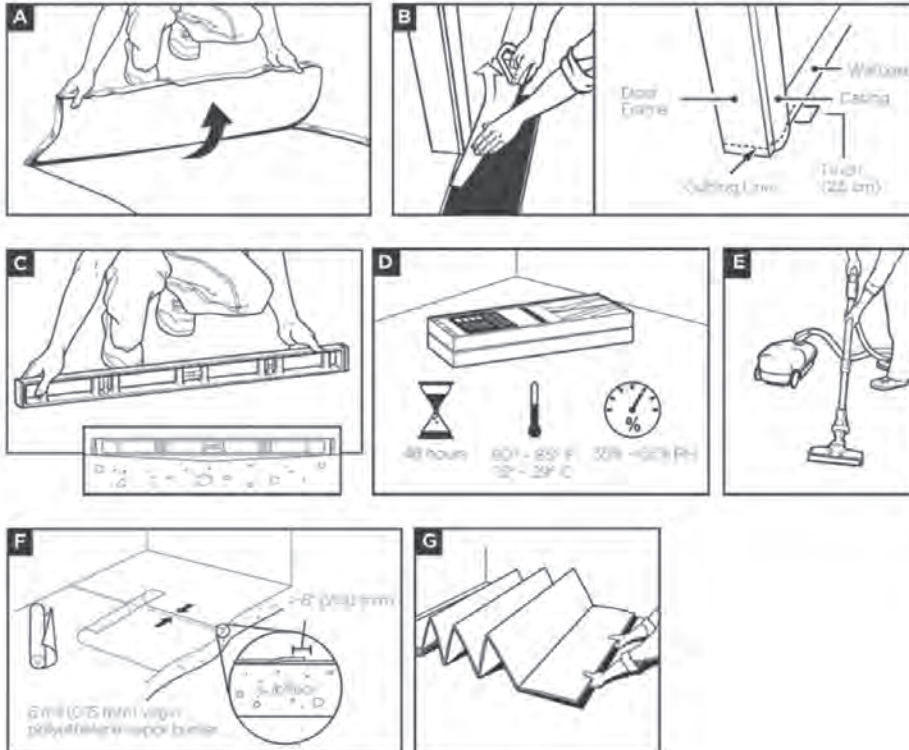

A) Remove carpet and padding. Also remove any wood flooring installed on concrete. Do not remove products unless they are asbestos-free.

B) Undercut door frame and wallbase. Slide the flooring at least 1/4" underneath the door frame and wallbase. Also leave a concealed 3/8" minimum expansion space under each.

C) Remove bumps or peaks in subfloor and fill depressions with floor leveling compound to ensure no more than 3/16" unevenness per 10-foot span.

D) Acclimate unopened product before installation. If there is no time for acclimation, there should be no more than a difference of 25° F ( $T(^{\circ}\text{C}) = (T(^{\circ}\text{F}) - 32) / 1.8$ ) and 20% relative humidity between the stocking/transportation environment of the flooring and the final installation environment of the flooring.

E) Clean debris from subfloor before installation.

F) For concrete subfloors, install vapor barrier with overlapped seams of 8" or more.

G) For planks without attached underlayment, install over single layer of underlayment appropriate for laminate floors. For planks with attached underlayment, it is acceptable to install underlayment prior to flooring installation if desired. Make sure to follow the installation instructions, taking special care to seal all foam edges with sealing tape and repair all rips and perforations in the underlayment vapor barrier prior to flooring installation. A separate vapor barrier should not be used in conjunction.

## RECOMMENDED TOOLS

Laminate installation kit (including spacers, tapping block, pull bar)

- Hammer
- Table or hand saw
- Carbide tipped circular saw blades
- Tape measure
- Duct tape
- Age-resistant, non-permeable polyethylene vapor barrier (0.0008 or 0.20mm) for installation over concrete
- Safety glasses
- Gloves

### Tools Required for Installation

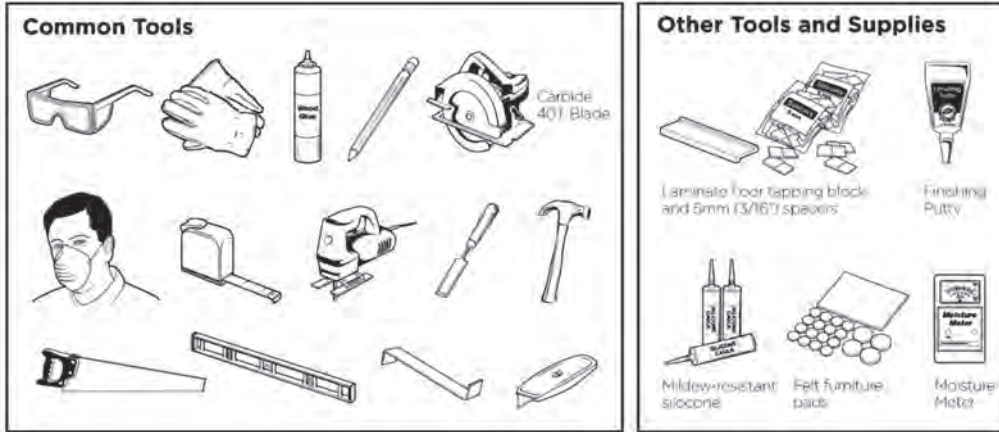

Safety Caution: use safety glasses and gloves when cutting this product. During the cutting process, laminate may create wood dust; be sure to install in a well-ventilated area.

It is important to understand the parts of the plank to ensure proper installation:

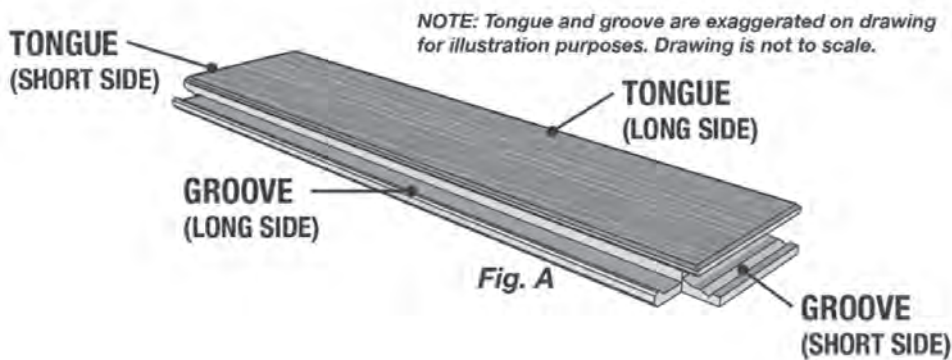

## FOLLOW THESE STEPS TO INSTALL YOUR NEW FLOORING

### STEP 1

**Prepare planks for first row installation.** Using a carbide-tipped circular saw blade, remove the tongue on the planks adjacent to the wall, allowing room for spacers (as shown in fig 2). Be sure to cut the TONGUE side (see fig A).

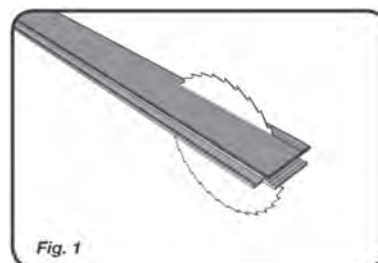



## STEP 2

Begin laying planks left to right, placing 5/16" spacers between the wall and the planks on either side of the joint. Be sure to place the cut tongue side against the wall as shown in illustration.

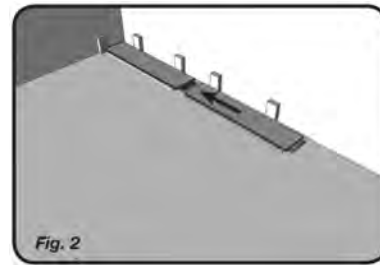

## STEP 3

Using the laminate flooring tapping block included in the kit, gently tap second plank against the short side, joining plank A and plank B.

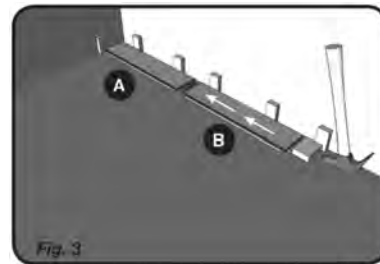

## STEP 4 - fig. 4

Begin installing the second row by angling the plank (plank C) to allow the tongue to slip into the groove of the plank in row 1. Push the plank down flat to the floor until it clicks into place. Do not force the plank closed as doing so can damage the joint.

**IMPORTANT: never tap the long end of the plank as doing so can damage the joint.**

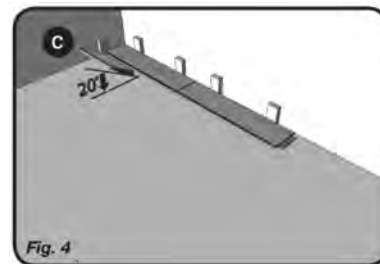

## STEP 5 - fig. 5

The next plank (plank D) should be installed in the same way but with the tongue on the left side of the plank falling just next to the previous plank. Push plank down flat to the floor as in step 4.

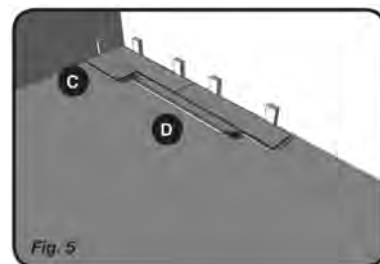

## STEP 6 - fig. 6

Once plank is flat, gently tap in the second plank against the short side of plank C, joining plank C and D (Fig. 6)

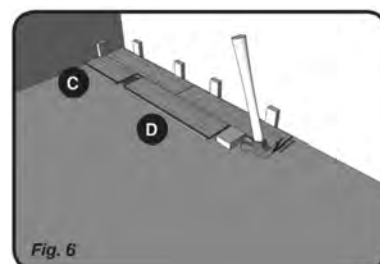

### STEP 7 -fig. 7

Continue laying the floor from left to right in the manner described in steps 2-6.

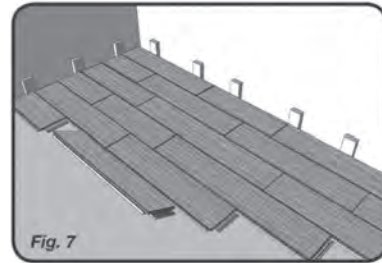

### FINISHING A ROW

### STEP 1 - Fig. 8a

When you come to the end of a row, you will need to cut the plank to complete the row. Flip a full sized plank over so that the tongue end points toward the wall, preserving the joint so that it can be inserted once cut. Mark where the plank should be cut, and cut with the décor side down. **If the remaining cut board is greater than 16" long, it can be used start the next row.**

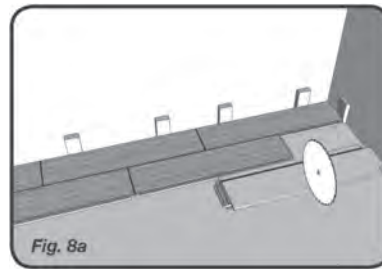

### STEP 2 - Fig. 8B

Flip the plank back over so that the tongue faces the groove of the adjacent plank; install as shown in Fig. 5.

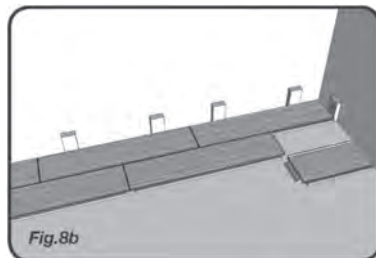

### STEP 3 - Fig. 8C

Because there is not enough space for a tapping block, tap the two sides together using a pull bar as shown in Fig. 9.

**IMPORTANT:** Do not use the leftover portion of this plank in the next row if it is less than 16" long.

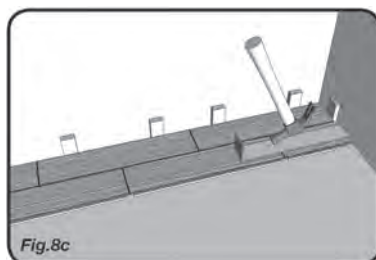

### INSTALLING AROUND OBSTACLES

In difficult to fit areas, such as door moldings, remove the lip on the groove edge of the planks you are fitting into. This can be done by lightly sanding or planing off the lip on the groove side of the plank, allowing the plank to be installed laying flat. Once the lip has been trimmed on the plank being fitted to, lay the plank flat on the floor. Apply a thin bead of PVAc-D3 laminate glue on the top of the tongue. Then push the plank into position. Once the plank is positioned, wipe off excess glue with a damp cloth and warm water.

### FINAL INSTALLATION:

Remove the spacers placed along the perimeter of the room. To cover the expansion space, install moldings around the perimeter of the room. Be sure to fasten the molding into the wall, not through the flooring. Quarter-rounds should be pre-drilled before nailing them to the wall.

Felt protection pads should be placed under furniture legs or other heavy objects to be left in place for a long period of time. Do not drag or pull heavy furniture, as doing so will damage the floor.

### CARE OF LAMINATE FLOORING:

Damp mop, using mild household cleaner in lukewarm water. Do not use abrasive cleaners.

### Care and Cleaning

A) Place felt floor protectors under legs of movable furniture. Chair casters should be rubber - not plastic or metal.

B) Place walk-off mats at entrances.

C) **Dust mop or damp mop only. NO wet mopping.** Use 1 cup of vinegar per gallon of water OR 1/3 cup ammonia per gallon of water. **DO NOT** use abrasive cleaners, detergents, soaps, waxes or polishes. Use correct hard surface vacuum tools. **DO NOT** use rotating beater bars, floor scrubbers, steamers, jet mops or similar products.

**DO NOT** allow liquids to stand on the floor. Wipe up spills immediately. **DO NOT** allow moisture to be on the floor for longer than 30 minutes.

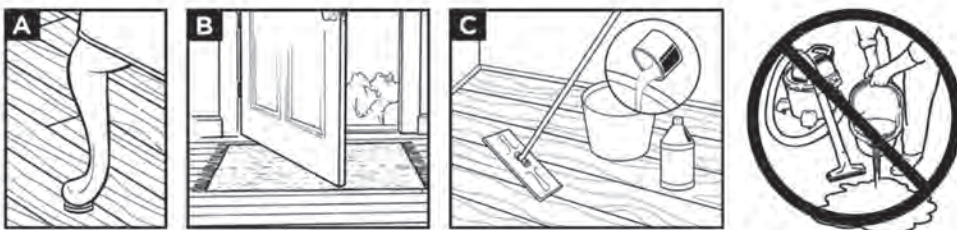

**Exercise:**

Persian meaning	Important word
	install
	sub floor
	stagger
	Leveling
	Concrete
	Carpeting
	Preparation
	Wall base
	Expansion
	Acclimate
	Stocking
	Debris
	Appropriate
	Underlayment
	Separate
	Conjunction
	Tongue
	Groove
	Plank
	Angling
	Scrubbers

## PART 2

### Installing brick facades



#### GENERAL GUIDELINES

##### CALCULATING HOW MUCH PRODUCT YOU'LL NEED

**Calculate** the amount of Brick you'll need for your project by following these steps:

- 1** Measure the width and height of all areas to be covered. Multiply width by height to determine the **total square footage** of the surface area. (1 foot = 30.48 centimeters)
- 2** **Estimate** the corners required by measuring the total length of the wall corners to be covered. This will equal the **number of linear feet of Brick corners** needed.
- 3** Subtract 75% of the corner calculation from the total square footage calculation you made in step #1. This will equal the **number of square feet of Brick flats** needed.

#### **Important Notes:**

If you intend on dry stacking the product on the wall (no mortar joints) you'll need 30% more product. Brick is packaged assuming that the product will be installed with

a minimum 3/8" mortar joint. Dry stack patterns are not recommended for exterior applications in cold weather climates where freeze-thaw cycles are anticipated.

**Example:**

Measurements:

Width of wall: 15 feet

Height of wall: 10 feet

Length of corners: **20 feet = total linear ft. of corners needed**

Calculations:

1 Multiply Width x Height:  $15 \times 10 = 150$  square feet

2 Multiply 75% x length of corners to be covered:  $0.75 \times 20 = 15$

(use this number below)

3 Subtract (2) from (1):  $150 - 15 = 135$  total sq. feet of flats needed



Standard 3/8" Mortar Joint



No Mortar Joint  
(Dry-Stacked)

**Exercise:**

Use this page to keep track of the measurements for your project.

**Take the Measurements:**

■ Measure width of wall in feet: .....

■ Measure height of wall in feet: .....

■ Measure length of corners to be covered: ..... = **Total linear feet of corners needed**

**Perform the Calculations:**

1 Multiply Width x Height: ..... x ..... = ..... Total square footage of surface area



2 Multiply 75% x length of corners to be covered:  $.75 \times \dots = \dots$   
 (use this number below)

3 Subtract the 75% calculation (2) from the total square footage calculation (1):  
 $\dots - \dots = \dots$  **Total square feet of flats needed**

**What Tools Will You Need?**

**Hammer:** Used for applying felt paper and metal lath.

**Wheel Barrow & Hoe or Bucket & Drill Paddle:** Used for mixing mortar mix.

**Notched Float or Float & Rake:** Used for applying scratch coat to metal lath and raking scratch coat.

**Circular Saw with Masonry Blade:** Used for cutting Bricks.

**Mason’s Trowel:** Used for applying mortar to Bricks.

**Grout Bag:** Used for grouting joints.

**Jointing Tool:** Used for finishing mortar joints.

**Whisk Broom:** Used for cleaning joints and Bricks.

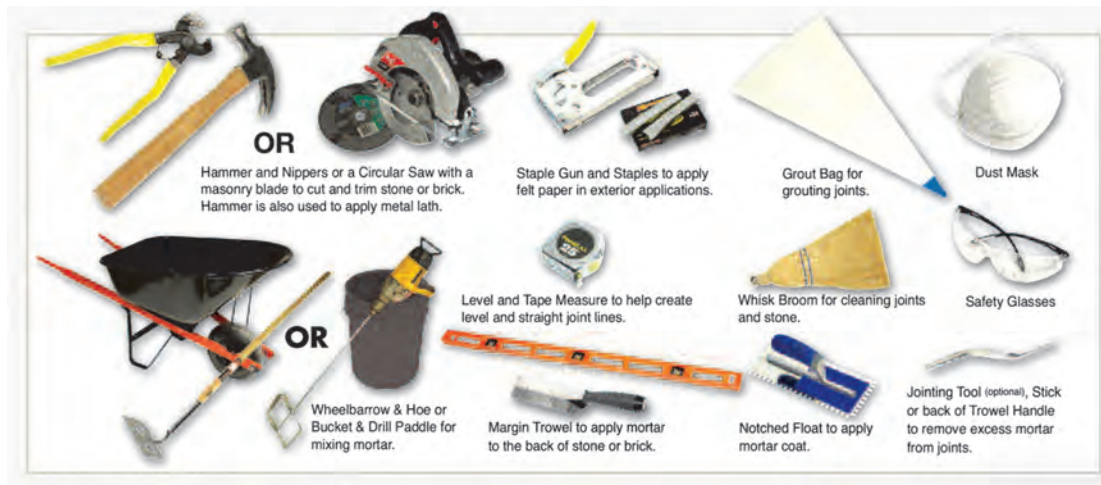

**Follow these steps to install bricks:**

**Step 1: Install Weather Barrier**

A weather resistant barrier should always be used when installing product over rigid backwall, wall-board, panelling, or wall sheathing.

Cover the walls and corners with the weather resistant barrier, overlapping the joints 4". Staple the weather barrier on to the wall with staples no more than 6" apart.



### Step 2: Install Metal Lath

Metal lath is installed over the weather barrier, and used as the foundation to which a mortar scratch coat will be applied, and onto which the thin brick will be installed. Secure the lath to your wall studs using 3/4" corrosive-resistant screws. Additional screws should be used between the studs and installed a minimum of 6" apart. Correctly installed, metal lath will feel rough to the touch going down and smooth going up. The rough side will grab and hold the mortar scratch coat. At the corners, overlap the vertical joints at least 16" around the corner to avoid corner cracking. Trim the lath around the edges with wire snips.



### Step 3: Mix Mortar

Mix up rich mortar in a tub, bucket, or wheelbarrow. Use the mixture formula described on the Materials Checklist (page 6), or combine mortar mix and water. Mix the mortar with a hoe or mixing stick, bringing it to the consistency of peanut butter.



### Step 4: Apply Scratch Coat and Allow to Cure

With a point trowel, scoop up some mortar and drop onto the flat trowel. Apply the mortar to the entire wall and corners - about 1/2" to 3/4" thick. This creates a "scratch coat" on top of the lath. Allow it to set up/ cure for 12-24 hours.

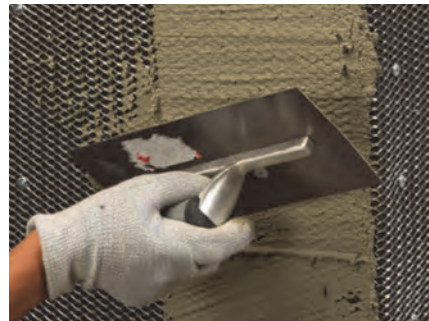



### Step 5: Lay Out and Clean the Product

While the scratch coat is curing, remove the Brick corners and flats from the box and lay them out in the desired pattern on a protected work table or floor. Keep in mind that the product may be sawn or chiseled during installation to fit precisely. Sponge off the back of the thin brick pieces to remove dust and help ensure a permanent bond to the wall.



### Step 6: “Butter” the Back of the Brick

Once the scratch coat is cured (nothing sticks to your hand when you touch it), you are ready to begin applying the thin brick. Wet the wall with water to provide moisture for the mortar on the thin brick to absorb and adhere to. Mix up mortar as described on the Materials Checklist (page 6). With the point trowel, apply mortar to the back of the thin brick, about 1/2" thick.



### Step 7: Install Thin Brick Corners

Beginning with the corner pieces, work either from the top-down, or bottom-up. Press the corner piece onto the wall, rotating back and forth slightly, and forcing some of the mortar to “squeeze out”. Vary your corner returns while working your way up or down the wall to avoid unattractive vertical mortar joints near the corners. Allow about 3/8" space between the brick pieces.



### Step 8: Install Thin Brick Flats

After the corner pieces are installed, apply flat pieces starting at an outside corner and working your way in. Remove excess mortar from around or on the brick with a sponge or stiff brush.



### Step 9: Cut Thin Brick as Needed

To cut pieces to fit the application, score the brick with a masonry blade about 1/4" deep and break the scored piece. Or, a small electric saw with a diamond blade may be used.



### Step 10: Fill Joints with Mortar

Once all of the brick is in place, use a mortar/grout bag to fill in the joints between the brick (unless you have chosen the dry-stack method in which case proceed to Step 12). Add colorant to the mortar if desired. Add more water to the mortar so that it is smooth and flows easily out of the bag. Fill the bag about half full with mortar, and twist the bag at the end. Fill the vertical and horizontal joints with mortar, and sponge or whisk off excess mortar that gets onto the brick face.



### Step 11: Smooth out Joints

As the mortar begins to stiffen to the consistency of wet beach sand, use a joint tool to smooth out the mortar joints to the desired depth. A stiff-bristled paint brush may also be used to push mortar into the crevasses and smooth joints.



### Step 12: Clean the Brick

Use a wet sponge or stiff brush to clean off any remaining mortar on the brick face.



## FAST ADHESIVE METHOD

For interior applications where moisture is not a concern, a **fast adhesive method** may be used instead of the metal lath method.

### Step 1: Install the Cement Fiberboard

Secure the fiberboard to your wall studs using 3/4" screws. Be sure to countersink the screws so the brick can bond properly to the board. At the corners, ensure the fiberboard meets at the ends so that there are no gaps. Thin brick may also be applied directly over water-resistant drywall. Applying thin brick directly over standard drywall may negatively affect joint quality and overall durability.

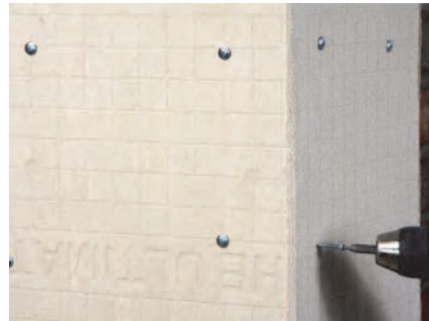

### Step 2: Install the Thin Brick

Start with the corner pieces, working either from the top-down, or bottom-up. Using a non-sagging adhesive, apply a generous bead to the back of each brick and firmly press into place on the wall.

Vary your corner returns while working your way up or down the wall to avoid unattractive vertical mortar joints near the corners (see Step 8). Allow about 3/8" space between the brick pieces unless you are dry-stacking the material. After the corner pieces are installed, apply flat pieces starting at an outside corner and working your way in. Let the adhesive dry overnight. Mix up mortar to fill mortar joints (see Step 3), and then continue with installation steps 10-12 .



### Care and cleaning

#### Cleaning Information

**1** In general, thin veneer units should be kept clean during the installation process. Mortar smears should be removed by gently dry-brushing and wiping with a damp sponge at the end of work periods. For general cleaning with non-acidic detergent cleaners is recommended. Pressure wash cleaning methods should not be used.

## Safety Information

When installing masonry products, it is recommended that you wear protective clothing, gloves, and eyewear.

### Weather Resistant Barriers (WRB)

- 1** A weather resistant barrier should always be used when installing product over rigid backwall, wallboard, plywood, paneling, or wall sheathing. General Shale recommends the use of two weather resistant barriers for exterior applications and/or a drainage-type system behind the thin veneer with a drainable panel, flashings, weep holes. Check your local codes prior to installation.
- 2** A weather barrier is not needed when the thin brick is being applied over masonry or concrete.

## Exercise:

Please fill out the following table from the options below

NUMBER	ITEM	PURPOSE
1	Tarp to cover floor	
2	Weather barrier sheet	
3	Staple gun	
4	18-guage galvanized metal lath	
5	3/4" corrosion-resistant screws (preferred) or nails	
6	Electric screwdriver or hammer	
7	Heavyweight trimming shears or wire snips	
8	Large sponge	
9	Mortar For Scratch Coat: 1 part Portland Cement to 2.5 parts sand For Buttering Units: 1 part Portland Cement to 2 parts sand For Joints: 1 part masonry cement to 2 parts sand	
10	Bucket or Wheelbarrow	
11	Hoe or large mixing stick	
12	Point Trowel	

NUMBER	ITEM	PURPOSE
13	Flat Trowel	
14	Masonry Blade	
15	Small electric saw - optional	
16	Mortar/Grout bag	
17	Joint tool	
18	Stiff brush (not a wire brush)	
19	Gloves	
20	Safety glasses	
21	Dust mask	

- To secure screws/nails into metal lath
- To mix mortar with
- To mix mortar in
- To create a masonry wall for brick to hold on
- Protection during mortar mixing
- To smooth out joints
- To secure metal lath
- To clean back of brick and eliminate dust
- To protect hands during installation
- To apply mortar to “scratch coat”
- Mortar mix for brick application/joint filling
- To custom-cut thin brick
- Installing weather barrier
- To fill in joints
- Floor protection - interior applications
- To wipe away excess mortar
- To cut metal lath
- To protect eyes during installation
- Protect wall from moisture
- To apply mortar to brick
- To score and break thin brick pieces to fit

**Exercise:**

Persian meaning	Important word
	Measure
	Estimate
	Subtract
	Mortar joint
	Dry stack
	bricks
	Weather barrier
	Wallboard
	Panelling
	Wall sheathing
	Overlapping
	Cure
	Consistency
	hoe
	Metal Lath
	Scratch Coat
	lay out
	Materials
	Adhere
	Squeeze out
	Smoth out
	Adhesive
	Countersink
	Non - sagging
	Veneer
	Barriers



## PART 3

### Installation Manual for Lay-in Modular Ceiling

Modular ceiling systems limited in both length and with either lay-in Bars or concealed Bars.

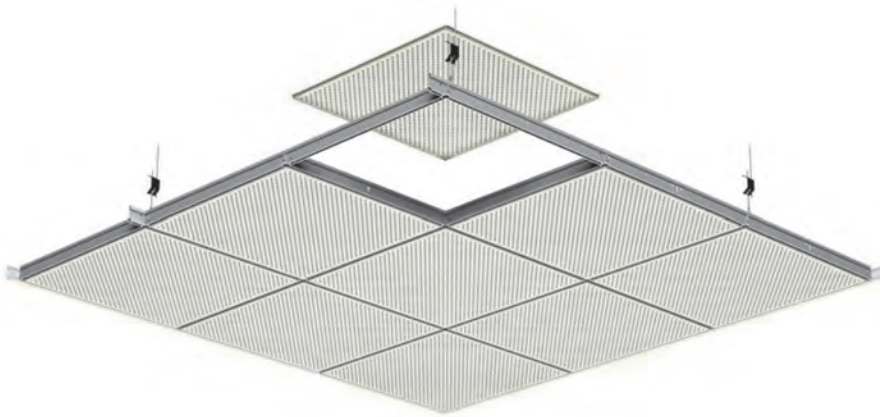

#### Storage and Handling

- Ceiling panels must be kept clean, dry, and protected from the elements. Remove the panels from the cartons 24 hours before installation to acclimatize to interior conditions.
- The installation site must be free from debris and dust.
- Irrespective of varying temperature and humidity recommendations which vary from product to product, all products must be stored in a interior space and not exterior space.

**Metal & Soft fibre**



**Mineral Fibre**





### Opening a grid carton



Step 1: Identify dotted line

Step 2: Cut along dotted line

Step 2: Open from one side

Step 3: Ready to remove

### Opening a mineral fibre tile carton

It is recommend that RH 99, 90 & 80 products are to be opened and left to acclimatize for 24 hours before fixing.

This makes the tiles dry and hard.



Wrong box opening method

Step 1: Cut the polythene film

Step 2: Remove the polythene film

Step 3: Remove the tile



## What Tools Will You Need?

### Tools



Measuring Tape



Distance meter



Line laser leveler



chalk line



Hand drill/driver



Rotary hammer machine



Wire snip



Aviation snip



Clamp



Knife



Pop Rivet



Slitting shear machine

### Safety & precautions

Ladders are recommended for ceiling heights from the flooring up to 3 meters, provided the flooring surface is level, with a plain finish.

Ladders are not recommended for ceiling heights exceeding 3 meters, a Platform with 4-sided pillars is recommended.

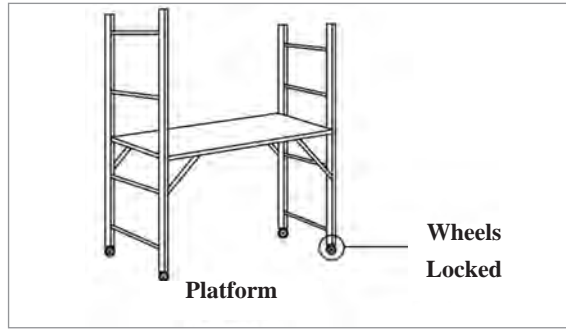





Wrong standing position    Right standing position

installers wear a tool belt for easy access to tools during installation.  
It is unsafe to keep tools on the ceiling tiles.

### Safety & Precautions

Personal protective equipment (PPE):

All installers **MUST** wear PPE consisting of hard hat, rubberized gloves, jacket, steel toes and glasses during installation of the ceiling system.

Item	Description
 Hard Hat	Prevents injury to the head from small falling objects at construction site.
 Rubberized Gloves	Prevents injury to the hand from flared edges.
 Jacket	Provides better visibility at low visibility construction site.
 Glasses	Prevents small particles while cutting from entering into the eyes and causing injury.
 Steel Toes	Prevents toe injury due to sharp or obstructive objects laying on the floor.



## Ceiling layout and components in modular ceiling

Sketch showing basic ceiling layout and placing of the components

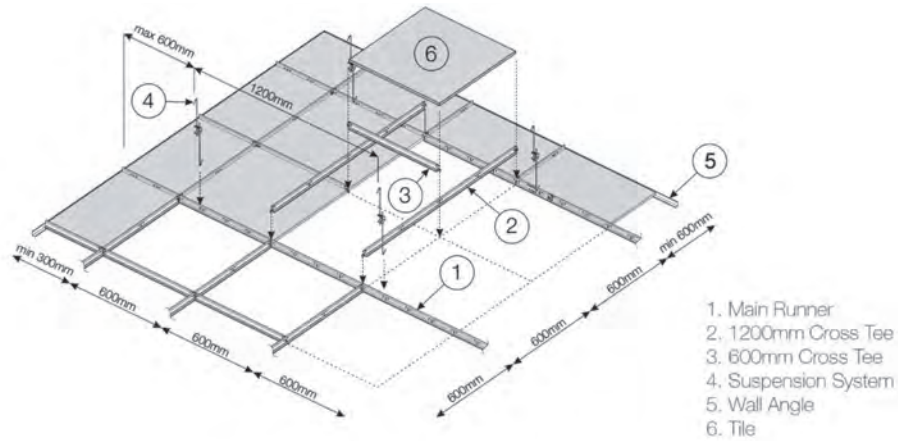

Follow these steps to install Modular ceiling:

### 9 Step Ceiling Installation Procedure

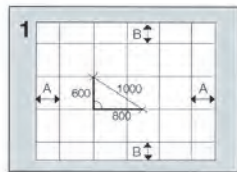

1.Planning grid layout

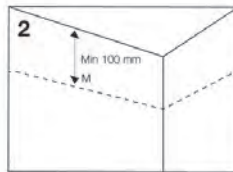

2. Mark perimeter trim lines

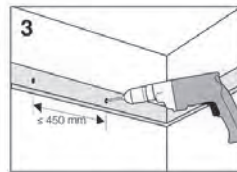

3. Installing perimeter trims (Wall angle)

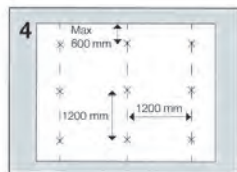

4.Mark hanger positions

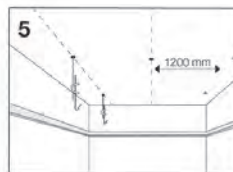

5.Installation of hangers

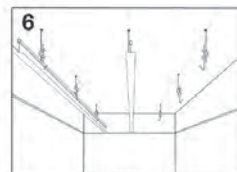

6. Installation of main Runners

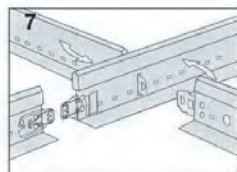

7.Cross Tees installation

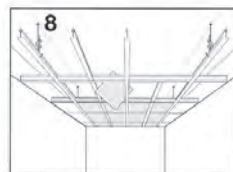

8.Installation of field and service tiles

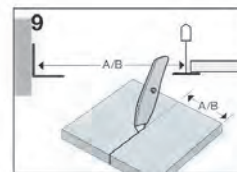

9.Measure and cut border tiles

## Step 1: Planning Grid Layout

### A) Wall to wall (with field and border tiles)

This is one of the most important step before commencement of actual ceiling installation. Here grid layout is arrived by taking into consideration room dimensions {length(l) x breadth(b) x height(h)} Points to remember: In practical conditions, often the room dimensions are not exactly square in dimensions.

Thumb rule: recommends to have border cut tiles greater than half the size of the ceiling tiles on all four sides of the wall.

Refer layout for diagram 1.1

Ceiling Module: 600mm x 600mm

Room dimensions: 4320mm x 2700mm (l x b)

Tiles calculation l: 4320mm

( incorrect calculation)= 7 full tiles + 2 x 60mm cut tiles

( Pcorrect calculation)= 6 full tiles + 2 x 360mm cut tiles

Note: Please follow the above method for breadth border cut tile calculation.

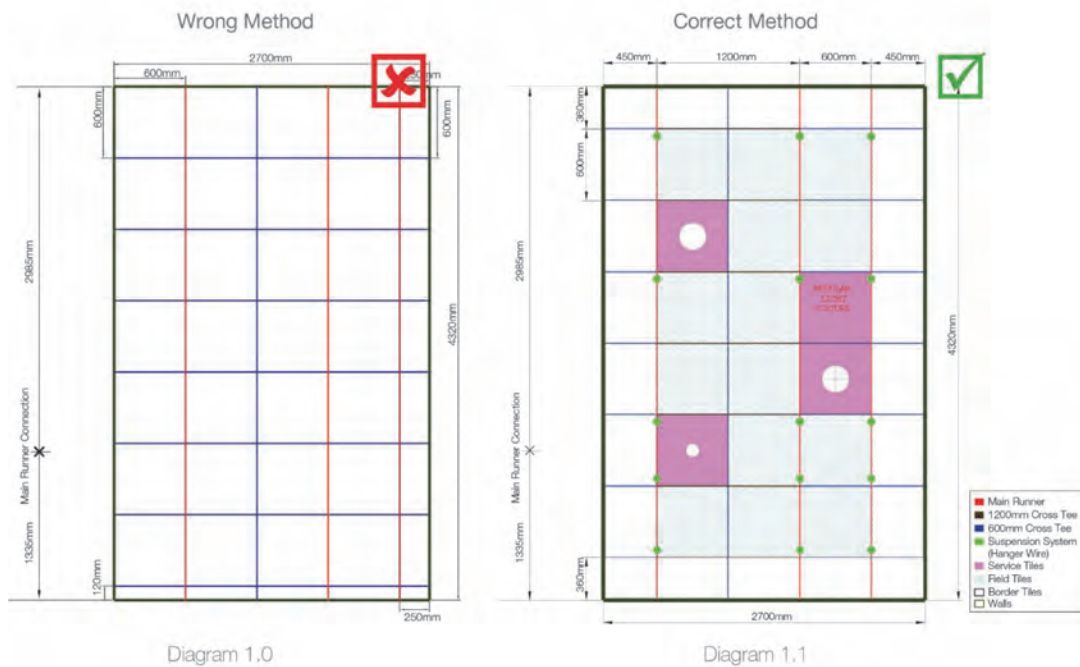

B) With Plaster bulk heads (full tiles module)

Plaster bulk heads are used to design spaces to enclose full border tiles and enclose vertical grilles for HVAC.

Below mention is a simple thumb rule to calculate ceiling installation with full border tiles. Assuming, we are developing a module of 3600mm X 3600 mm i.e 6 tiles X 6 tiles within the plaster bulk head.

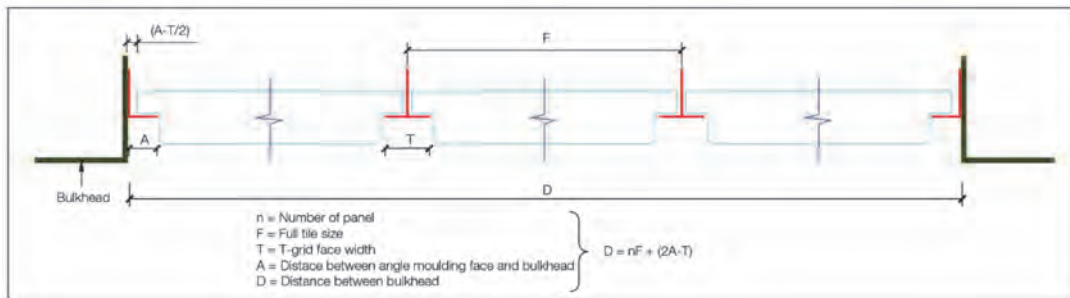

Most often one would take an internal measurement, between the bulkheads of 3600mm X 3600mm.

But this is an incorrect method and while doing final installation, you may end up cutting the border tiles on all the four sides.

Thumb rule: Add two sides wall angle width and deduct the width of the main tee to get the extra length.

Assume we use 19mm wall angle and 24mm grid facing, then the overall length should be 3614mm to achieve the full tile visual.

Thumb ● rule calculation

Description	Wall Angle Size (mm)	Steel Angle Face Width	
		15mm	24mm
Wall Molding	19x19x3000mm	Add 23mm	Add 14mm
Shadow Molding	19x7x7x14x3600mm	Add 13mm	Add 04mm
Wall Molding	32x24x3000mm	Add 33mm	Add 24mm
Aluminium Wall Molding	19x25x3000mm	Add 35mm	Add 26mm
Stainless Steel Wall Molding	19x32mm	Add 49mm	Add 40mm
Wall Molding	22x22x3000mm	Add 29mm	Add 20mm

Note: The addition to the original length or breadth will avoid the need for border tiles.



### Step 2: Mark Perimeter Trim Lines

- Measuring the ceiling height is the most crucial stage before commencing installation.
- The minimum plenum height from the ceiling slab should not be less than 100mm for lay-in system.
- The reference ceiling level should be established by the main contractor with the help of all other services vendors like light fixtures, Air condition grilles, sprinklers, speakers etc.
- Using a plumb mark as a reference point, place line laser leveller on it. Then with the help of laser point, mark wall angle level on all sides of the room.



### Step 3: Installing Perimeter Trims (Wall Angle)

- The marking with the help of line laser leveller has to be done above the wall angle level on all the walls.



- Post marking used hand drill to installed the wall angle.
- The first and the last fasteners on wall angle should be installed at 150mm from the wall (see for details recommended fastener on page no.19).
- Subsequent fasteners to be installed at 450mm spacing in between.



- At the corners of the room, the conjunction area of wall angle should be miter cut for a clean finish

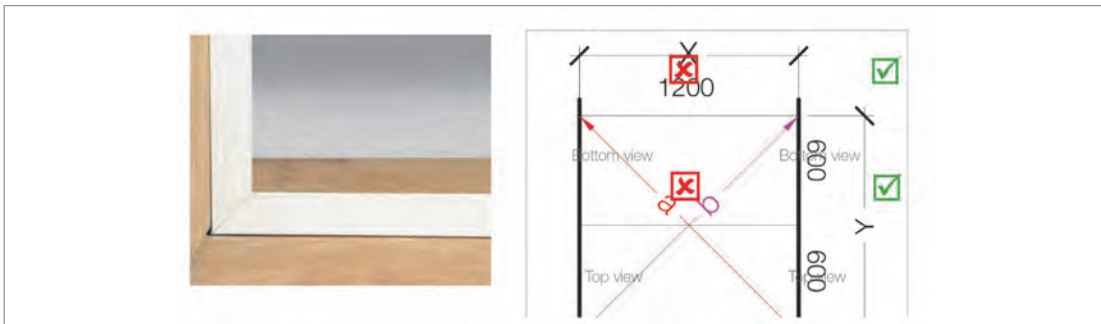

- The hanger on the main runner should be placed at or within 600mm distance from the wall angle (450mm is recommended in case of heavier ceilings) and then subsequently at 1200mm centres.

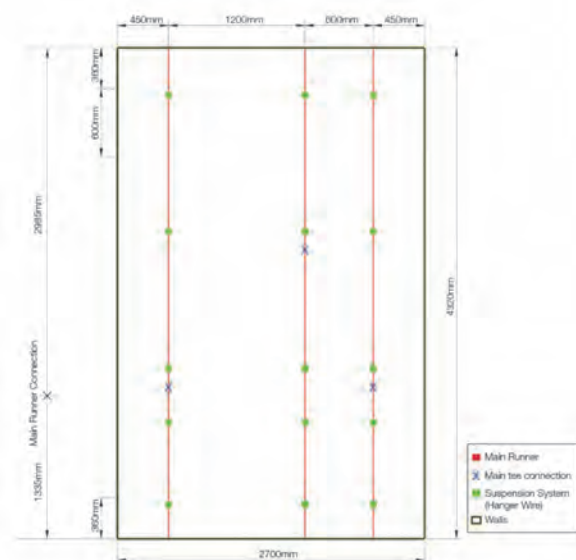

Diagram 1.0

بودمان پنجم: کسب اطلاعات فنی

There should also be a hanger within 150mm of any main runner to runner connection.

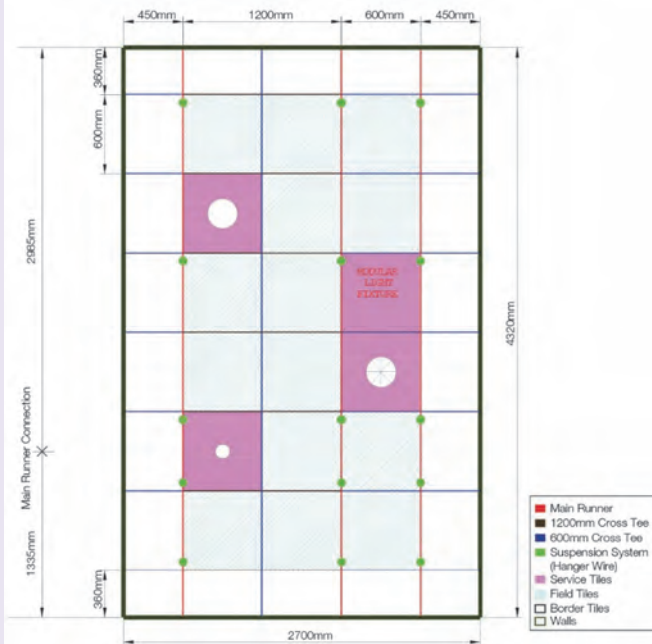

Diagram 1.1

#### Step4: Installation of Hangers

Use a rotary hammer machine to drill and install the hangers from the concrete ceiling slab.

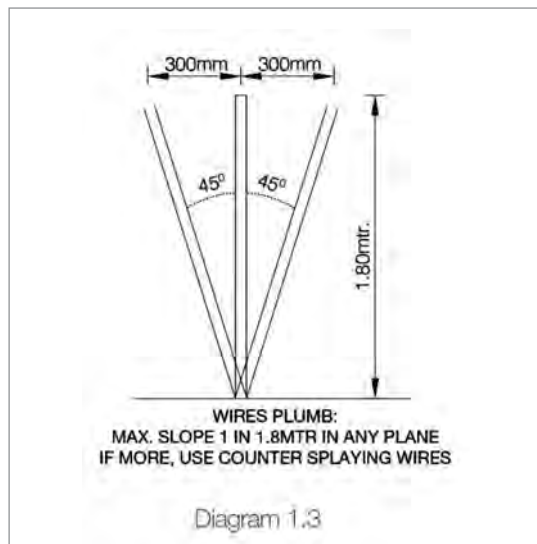

Diagram 1.3



- If the hanger wire plumb more than 1.8 meter then use counter splaying wire refer above diagram.
- In counter splaying, two hanger wires from the structural slab form an angle of 45° near the main runners. One suspension countering another in the same plane.
- Install the hanger wire as per the position in the diagram 1.1.
- Suspension hanger wire shall be pre-straightened with minimum 2.5mm dia (# 12 Gauge).
- Insert wire of required length into hanger wire hole and encircle the wire 3 times within 75mm.

Installation under AC duct

- If AC duct is greater than 1200mm in length, then ensure you suspend a separate bracket under the duct and from it, a hanger-wire can be suspended for ceiling installation.

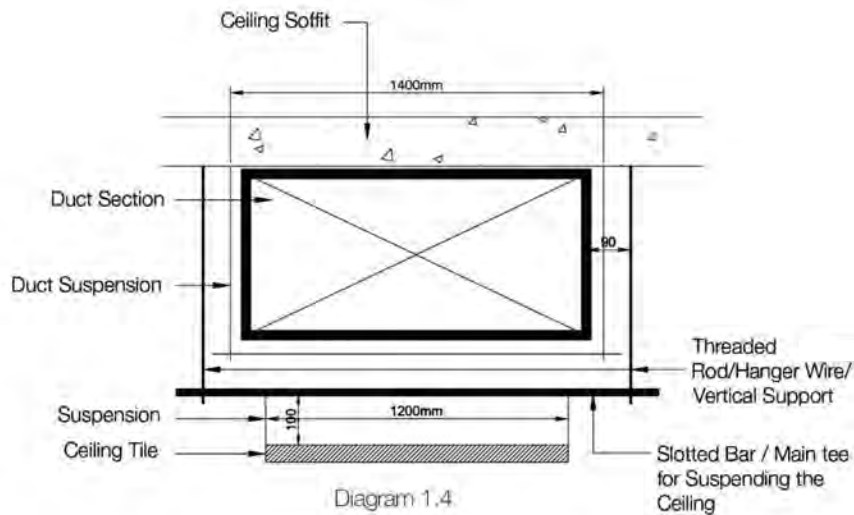

Typical Sectional Sketch - Below Duct Suspension (Trapeze Installation)

### Step 5: Installation of Main Runners

Run a string line the length of your first main runner offset to the edge flange. This will help to keep the main runner set distance of the wall.

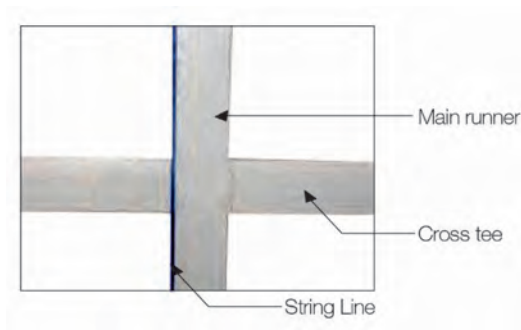

بودمان پنجم: کسب اطلاعات فنی

- Cut the main runner to the length with respect to the border tile, so that the rout hole on the adjacent main runner matches.
- E.g. As per diagram 1.5, the main runner will be cut at 15 mm using an aviation snip cutter to ensure that the rout hole will be at a distance of 360 mm.

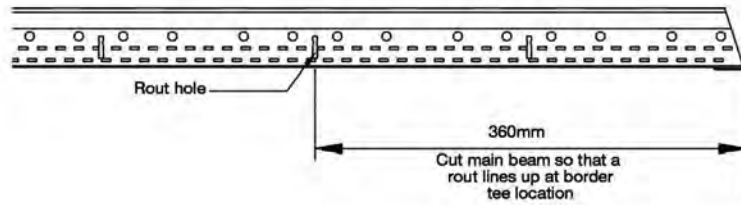
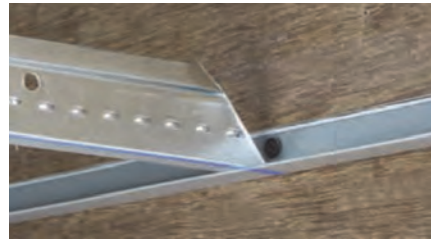

Diagram 1.5

- Cut the main runner at inclination of 30-45 degree to avoid obstruction of protruding screws.



Armstrong provides following grids.

Grids	Rout Hole Interval (mm)	Distance of 1st Rout Hole from the End Clip (mm)
Prelude 32	150mm	75mm
Prelude 38	150mm	75mm
Prelude 43	100mm	50mm
Suprafine 32	150mm	75mm
Suprafine 38	150mm	75mm
Suprafine 43	100mm	50mm
Silhouette 38	600mm	300mm
Silhouette 45	600mm	300mm
Select 38	600mm	300mm
Select 45	600mm	300mm

- The first main runner should be less than 600mm from the perimeter wall.
- The distance between next main runner shall be at 1200 mm maximum.
- You may incline the first suspension system slightly to push the main runner in one direction so that the rout holes are better aligned.
- Hangers with hook clip options can be inserted in alternate direction on the main runner for better stability.
- Border cross tees should be more than 300mm but less than 600mm in length.

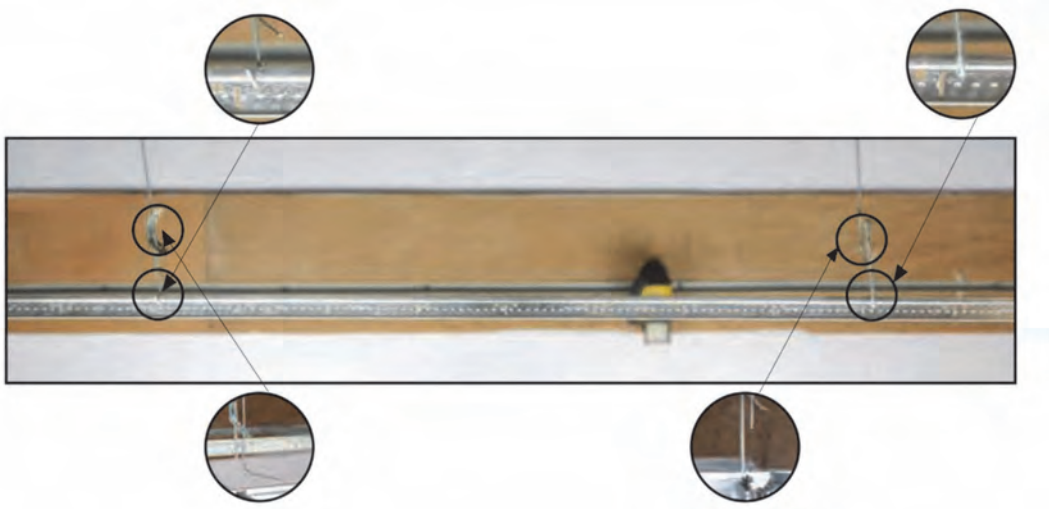

- Cut the excess portion or bend the wire as shown in the picture.
- Insert an additional row of main runner or alternatively suspend all border cross tees longer than 600mm.

### Step 6: Cross Tees Installation

- As per diagram 1.1 (page 5) install border cross tee 448mm (2mm allowance is kept for cross tee to rest on the wall angle easily).
- Install border cross tees temporarily to the wall molding using a clamp to keep them intact.



بودمان پنجم: کسب اطلاعات فنی

- Install two 1200 cross tees between the two main runners at an distance of 600mm.
- A click sound confirms that the cross tee has been properly locked into the main runner.

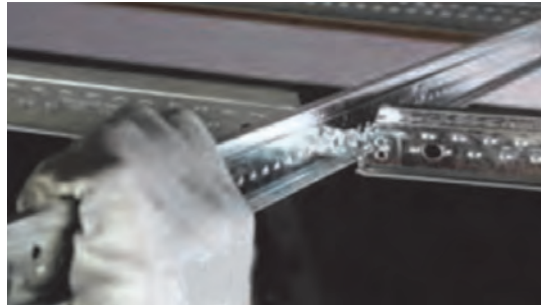

- Measurements should be taken diagonally in the 600 x 1200mm module. Both the diagonals must be of the same length.
- In case of any deviation in the measurement of the diagonals gently tap at the corners.
- This will ensure that the entire ceiling grids will be in a perfect shape.

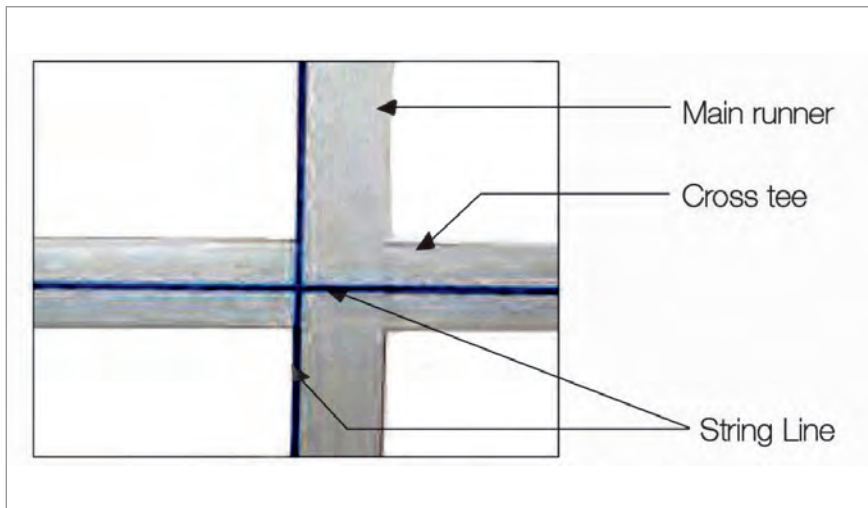
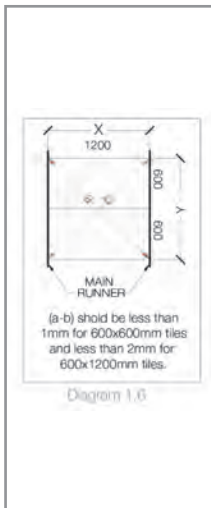

Once the system is in perfect shape run another string line at the first cross tee slot on the main runner to the far adjacent wall angle using the first two square mains as the guide. This ensure the tee rout holes on all the main runners stay in aligned.

### Step 7: Installation of Field and Service Tiles

- Check the level once again using line laser leveller.
- Ensure that all the services placed on service tiles are tested and confirmed by the principal contractor. Only after that, laying of field tiles can be commenced.



- While installing down lighters, spotlights, sprinklers, speakers, smoke detectors etc. 6mm plywood (pattress backing must be placed on the grid).



- It is mandatory to independently suspend modular light fixtures.
- GI wire 2.5 mm is recommended to suspend the light fixtures.
- Hook Clips and Chains are not recommended.





پودمان پنجم: کسب اطلاعات فنی

## Step 8: Measure and Cut Border Tiles

■ Measure the border tile size.



■ Mark the border size on back side of the tile.



■ Use a grid or a steel ruler (2 ft long) to mark and cut the border tiles.



■ While installing, slightly tilt the tile and gently rest it on the main runner and adjacent cross tee and wall angle.



How to make tegular and curved shape edges on border tile

A) Tegular edge

- Use a sharp knife.
- Lay the tile on a smooth surface.
- Make vertical cut into face of the tile.
- Make horizontal cut to form tegular edge.



### Glossary

- 1** Plenum: The space between the main structural slab and suspended ceiling is called the plenum.
- 2** Tegular: A functional edge detail that allows a suspended ceiling tile to extend below the grid, making the grid less noticeable.
- 3** Rout hole: A hole on main runner to insert and lock the cross tees on the main tee.
- 4** Plumb mark: Measuring either from the floor or roof level and marking the ceiling height is known as plumb mark. From the plumb mark point, the entire ceiling level will be marked.
- 5** Plaster bulkheads: Plaster bulk head is otherwise called Plaster board boxing. Plaster bulkhead is designed to accommodate HVAC grilles vertically.
- 6** Flange: The visible area of the grid from below the ceiling i.e. the horizontal surface on the face on the main runner or cross tee.

**Exercise:**

Persian meaning	Important word
	Manual
	Ceiling
	Concealed
	Strage
	Handling
	Acclimatize
	Recommendation
	Interior
	Exterior
	Precaution
	Platform
	Pillars
	Components
	Plaster
	Grills
	Thumb
	Bulkhead
	Trim Lines
	Sprinklers
	Vendorslike
	Angle level
	Subsequent
	Suspension
	suspended
	Flange
	Adjacent
	Inclination
	Obstruction
	Protruding
	Clamp



### جدول ارزشیابی پودمان

نمره	استاندارد (شاخص‌ها، داوری، نمره‌دهی)	نتایج	استاندارد عملکرد (کیفیت)	تکالیف عملکردی (شایستگی‌ها)	عنوان پودمان (فصل)
۳	بیش از ۸۴ درصد موارد را انجام دهد.	بالاتر از حد انتظار	استخراج اطلاعات فنی و دستورالعمل‌های اجرائی در کارهای معماری داخلی از دفترچه‌های راهنما و متون به زبان انگلیسی و به کارگیری آنها در کارهای اجرائی.	کسب اطلاعات فنی تخصصی معماری داخلی	کسب اطلاعات فنی
۲	۶۰ تا ۸۴ درصد موارد را انجام دهد.	در حد انتظار			
۱	کمتر از ۶۰ درصد موارد را انجام دهد.	پایین‌تر از انتظار			
				نمره مستمر از ۵	
				نمره شایستگی پودمان از ۳	
				نمره پودمان از ۲۰	

- ۱ ارشاد، فرهنگ. مهاجرت تاریخی ایرانیان به هند. تهران. پژوهشگاه علوم انسانی و مطالعات فرهنگی. ۱۳۷۴.
- ۲ ارشاد، محمدرضا. گستره اسطوره. تهران. هرمس. ۱۳۸۶.
- ۳ افشار مهاجر، کامران. نمادگرایی در هنرهای سنتی. هنرنامه، شماره ۶. ۱۳۷۹.
- ۴ الکساندر، کریستوفر. معماری و راز جاودانگی. مترجم: مهرداد قیومی بیدهندی. تهران. دانشگاه شهید بهشتی. ۱۳۸۶.
- ۵ اوداینیک، ولادیمیر والتر. یونگ و سیاست. مترجم: علیرضا طیب. تهران: نشر نی. ۱۳۷۹.
- ۶ اهرارت، اچ. بایرون. دین ژاپن: یکپارچگی و چندگانگی. مترجم: ملیحه معلم. تهران. سمت. ۱۳۸۴.
- ۷ آنتونیادس، آنتونی سی. بوطیقای معماری. تهران: سروش. ۱۳۸۶.
- ۸ آنه ساکی، ماساهارو. دین شین تو. مترجم: ی. ع. پاشایی، هفت آسمان، سال دوم، شماره ۵، بهار ۱۳۷۹.
- ۹ اونو، سوکیو. شین تو: راه کامی. مترجم: نسترن پاشایی. تهران: نگاه معاصر. ۱۳۸۱.
- ۱۰ ایزدپناه، مهرداد. آشنایی با ادیان چین و ژاپن. تهران: محور. ۱۳۹۰.
- ۱۱ ایونس، ورونیکا. شناخت اساطیر هند. مترجم: جلال فرخی. تهران: چاپ گلشن. ۱۳۷۷.
- ۱۲ بنیون، لارنس. روح انسان در هنر آسیایی. تهران: وزارت فرهنگ و ارشاد اسلامی. ۱۳۸۳.
- ۱۳ پاشایی، عبدالرحیم. دانشنامه دین. فصلنامه هفت آسمان. شماره ۶. ۱۳۷۹.
- ۱۴ پاشایی، عبدالرحیم. طبیعت در هنر ژاپنی با اشاره به مفهوم غربی آن. مرداد. شماره ۸۳. ۱۳۸۴.
- ۱۵ پاشایی، عبدالرحیم. هنر ژاپنی. مجله هنرهای تجسمی. بهمن. شماره ۲۱. ۱۳۸۳.
- ۱۶ پیرنیا، محمد کریم. سبک‌شناسی معماری ایرانی. تهران. سروش دانش. ۱۳۸۶.
- ۱۷ اسلامی، محمدحسن. جعفرآبادی، محسن. آقازاده هریس، احمد. لیلاز مهرآبادی، امیر. تأسیسات ساختمان. چاپ و نشر کتاب‌های درسی ایران. ۱۳۹۶.
- ۱۸ سایت‌ها و منابع اینترنتی.
- ۱۹ قدیری مقدم، اصغر، تأسیسات حرارتی، چاپ و نشر کتاب‌های درسی ایران، ۱۳۸۷.
- ۲۰ میرمنتظری، سیدحسن، کارگاه تأسیسات بهداشتی، چاپ و نشر کتاب‌های درسی ایران، ۱۳۸۸.
- ۲۱ لیلاز مهرآبادی، امیر، نقشه‌کشی تأسیسات، چاپ و نشر کتاب‌های درسی ایران، ۱۳۸۵.



سازمان پژوهش و برنامه‌ریزی آموزشی جهت ایفای نقش خطیر خود در اجرای سند تحول بنیادین در آموزش و پرورش و برنامه درسی ملی جمهوری اسلامی ایران، مشارکت معلمان را به‌عنوان یک سیاست اجرایی مهم دنبال می‌کند. برای تحقق این امر در اقدامی نوآورانه سامانه تعاملی بر خط اعتبارسنجی کتاب‌های درسی راه‌اندازی شد تا با دریافت نظرات معلمان درباره کتاب‌های درسی نونگاشت، کتاب‌های درسی را در اولین سال چاپ، با کمترین اشکال به دانش‌آموزان و معلمان ارجمند تقدیم نماید. در انجام مطلوب این فرایند، همکاران گروه تحلیل محتوای آموزشی و پرورشی استان‌ها، گروه‌های آموزشی و دبیرخانه راهبری دروس و مدیریت محترم پروژه آقای محسن باهو نقش سازنده‌ای را بر عهده داشتند. ضمن ارج نهادن به تلاش تمامی این همکاران، اسامی دبیران و هنرآموزانی که تلاش مضاعفی را در این زمینه داشته و با ارائه نظرات خود سازمان را در بهبود محتوای این کتاب یاری کرده‌اند به شرح زیر اعلام می‌شود.

#### اسامی دبیران و هنرآموزان شرکت‌کننده در اعتبارسنجی کتاب دانش فنی تخصصی رشته معماری داخلی کد ۲۱۲۶۰۴

ردیف	نام و نام خانوادگی	استان محل خدمت	ردیف	نام و نام خانوادگی	استان محل خدمت
۱	الهه صحت	خراسان رضوی	۹	بهاره آلتون کیانی	کرمانشاه
۲	راحله باباپور	خراسان شمالی	۱۰	نسرین شاهی	آذربایجان شرقی
۳	اکرم سادات موسوی نیا	مرکزی	۱۱	فاطمه رضوانی	هرمزگان
۴	محمد حاجی محمدقلیان	قزوین	۱۲	نعیمه جلالی میلانی	آذربایجان شرقی
۵	محمد اسکندری	شهرستان‌های تهران	۱۳	بیبا سوزنی	کرمانشاه
۶	نیکناز کچویی	خراسان رضوی	۱۴	جواد کورش فرد	فارس
۷	علی عشوریان	اصفهان	۱۵	مانیا مکاری	همدان
۸	ملیحه قره چلو	شهرستان‌های تهران	۱۶	مهدی ولی زاده	ایلام